



Datafox GmbH • Dermbacher Straße 12-14 • D-36419 Geisa • www.datafox.de

Manual

Datafox EVO 3.5 Universal

Flexible data collection with method



© 2021 Datafox GmbH

This document has been created by Datafox GmbH and is copyrighted against third parties. Datafox GmbH considers all contained information, knowledge and depictions as its sole property. All rights, including also translation, reprint or copy of the whole document or parts of it, require written consent of Datafox GmbH.

The assertion of all rights in this respect is reserved to Datafox GmbH, especially in case of the grant of a patent. The handover of this documentation does not establish a claim to the license or the use of the soft- and hardware. Copies of the floppy disks and CDs may only be made for the purpose of data backup. Every unauthorized copy of this documentation or the Datafox software will be prosecuted.

Alternations

Alternation in this Dokument

Date	Chapter	Discription
26.11.2018	all	Revision the manual to new version 04.03.11.xx
25.06.2021	all	Revision the manual to new version 04.03.17.xx

Alternations of the version

With the device generation IV a new versioning scheme has been introduced. According to this scheme the file name of the device firmware and the setup program (DatafoxStudioIV) is composed as follows:

Product name	XX. Device genera- tion	YY. Compatibility (which versions can be used to- gether)	ZZ. Version number (functional exten- sion)	Build Troubleshooting (with a new version the Build number is reset)
z. B. AE-MasterIV	04.	03.	9.	04

The use of the manual depends on the version of the firmware and the DatafoxStudioIV or the DFComDLL. Gather from the following table which manual matches which version. For different combinations no support can be offered.

Firmware, StudioIV and DLL validity: 4.03.17.xx.

The DatafoxStudioIV is backward compatible. This means that you can configure a device with a newer DatafoxStudioIV also older firmware, the device only supports the natural functions that are implemented in the older firmware version. I.e., relevant to the functions that are possible, is always the manual state that the firmware associated with the Setup equivalent. It is not possible to provide a centering firmware configured with a stand of DatafoxStudioIV to who is older than the firmware. recommendation:

If possible, use always the current version of DatafoxStudioIV.

What features are supported in which software versions, is from the file:

Datafox MasterIV, SW version xxx.pdf list as shown.

The file is located on the Datafox DVD and for download on the homepage. Please also note the instructions in each chapter in the manual. The updates are available on our website under www.datafox.de download.

Inhalt

1.	For your Safety	1
2.	Introduction	2
2.1.	Structure of the Documentation	2
2.2.	Guarantee Restriction	2
2.3.	Typography of the Documentation.....	3
2.4.	Important General Notes	3
3.	Intended Use and Environmental Protection	5
3.1.	Regulations and Notices	5
3.2.	Power supply	5
3.3.	Environmental Influences	5
3.4.	Mounting outdoors	6
3.4.1.	Temperature	7
3.5.	Repair	7
3.6.	Cleaning	8
3.7.	Further Notices	8
3.8.	Disposal	9
3.9.	General Hardware Information.....	10
3.9.1.	Hardware equipment	10
3.9.2.	Behavior in case of power failure	10
3.9.3.	UPS.....	10
4.	System Requirements / Hardware	11
4.1.	System Structure	11
4.2.	Requirements for Operating Datafox Devices	11
4.3.	Compatibility	12
4.3.1.	Firmware File Archive (*.dfz).....	12
4.3.2.	Datafox Devices and Device Firmware	12
4.3.3.	Device Firmware and Device Setup	13
4.3.4.	Device Firmware and Communications DLL	13
4.3.5.	Communications DLL and DatafoxStudioIV	13
4.3.6.	DatafoxStudioIV and Device Setup	13
4.3.7.	Update / Downgrade.....	14
5.	Device	15
5.1.	Commissioning.....	15
5.2.	Guideline for Commissioning	16
5.2.1.	Set-up of the device.....	16
5.2.2.	Installation of the Device.....	16
5.2.3.	Troubleshooting during Commissioning	16
5.3.	Operation and display elements of the Evo 3.5 Universal	17
5.3.1.	Composition and Operation EVO 3.5 Universal	17
5.3.2.	Display setup and bios of the EVO-Line 3.5.....	18
5.3.2.1.	Structure display "normal display" 3.5 Universal	18
5.3.2.2.	Structure Display EVO 3.5 Universal in the Bios menu	19
5.4.	Installation of the 3.5 Universal	24
5.5.	Connecting of KYO Onleloc and EVO 3.5 Universal.....	25
5.5.1.	Connection of digital in-/outputs.....	27
5.5.1.1.	Digital Output one	27
5.5.1.2.	Digital Output two	27
5.5.1.3.	Digital inputs	28
5.6.	Communication of Hardware V4 Devices.....	29
5.6.1.	Communication via USB	29
5.6.1.1.	Automatic detected connected USB to PC.....	30

5.6.2.	Installing USB driver for Hardware V4 Devices	31
5.6.3.	Communication via TCP / IP	32
5.6.3.1.	Communication TCP / IP via network-cable	33
5.6.3.2.	Communication TCP / IP via wLAN / Wifi.....	34
5.6.3.3.	Texas Instruments TI-CC3135 (Generation 2)	35
5.6.3.4.	Redpine (Generation 1)	36
5.6.3.5.	Connection of the Terminals via TCP/IP DNS / DHCP	38
5.7.	Connection and wiring of the access control	40
5.7.1.	Configuration and structure of the Access control	40
5.7.2.	Description of Tables for Access Control 2	43
5.7.3.	Status messages of the access control.....	46
5.7.4.	Wiring of the access-control reader	52
5.7.4.1.	Connecting of one access-control reader.....	52
5.7.5.	Instructions for the electrician for installing the access control system	56
5.7.5.1.	Star-shaped bus wiring	56
5.7.6.	Calculation for the power supply of Access modules	58
5.7.7.	Cable length and cable cross section for access wiring	59
5.7.8.	Online functions for the access control	60
5.7.8.1.	Online via http-protocol	60
5.7.8.2.	Online via DLL connection	63
5.7.9.	Function extention for access control II.....	64
5.7.9.1.	General description.....	64
5.7.9.2.	Examples.....	65
5.7.9.3.	Description of the table „Action2“.....	69
5.7.9.4.	Additional functions for Access Control.....	70
5.7.9.5.	List Presence.....	71
5.8.	RFID Reader	72
5.9.	Fingerscanner optical sensor	73
5.9.1.	Menu Page - Check Finger	74
5.9.2.	Menu page - "Teach in" fingerprints	74
5.9.3.	"Training" menu page	75
5.9.4.	Menu page - Delete	76
5.9.5.	Menu page - "Exit	76
6.	Technical Data of EVO 3.5 Universal	80
6.1.	communication modules.....	81
6.2.	access modules	81
6.3.	Module digital in and out.....	81
6.4.	Modules miscellaneous.....	81
7.	FAQ	81
8.	Index	82

1. For your Safety

Safety Information for Datafox Products



The EVO 3.5 Universal must only be operated according to the instructions given in the manual. Do not insert any foreign objects into the openings and ports. The device must not be opened. All maintenance work must only be performed by authorized specialists.



Some devices contain a lithium ion battery or a lithium battery. Do not throw into fire!

Supply voltage: 12 Volt DC
See respective type label / technical data.
The device must only be operated with a power-limited power supply according to EN 60950-1. If you do not observe these instructions, the device may be damaged.

Attention!

The following temperature ranges must be observed

Working area / storage temperature:	-20° C bis +70° C
Mobile communications module:	-20° C bis +55° C



In areas with cellphone ban, GPRS, WLAN and other cellular modems must be turned off.

Persons with heart pacemakers:

When using the device, maintain a distance of at least 20 cm between the heart pacemaker and the device in order to avoid possible interferences. Turn the device off immediately if interferences are assumed.



Protection class: Observe the technical data of the respective device. In case of laser devices of class 2, the eye is protected by the blink reflex and/or turning reactions if you briefly and accidentally look into the laser beam. The devices may be used without further protective measures. Nevertheless, avoid looking directly into the laser beam of the laser scanner

Observe the additional notes in the chapter,
“Proper use and environmental protection”



We declare under our sole responsibility that the product described fulfills the protection requirements of European Directive 89/336 / EEC as amended by 91/236 / EEC, 92/31 / EEC, 93/97 / EEC and 93/68 /. See the manual of the devices for the standards. Evidence is provided by compliance with the following standards: EN 55022 : 2010

- EN 55024 : 2010 + A1 : 2015
- EN 61000 – 6 – 2: 2005
- IEC 61000-3-2 : 2014
- IEC 61000-3-3 : 2013
- IEC EN 60950-1 : 2006 + A11 : 2009 + A1 : 2010

2. Introduction

Datafox data terminals have been developed to fulfill the requirements of modern personnel time recording where users have high demands concerning flexible and elegant design. Furthermore, the Datafox Embedded-Concept also covers access control. All relevant data can be recorded with modern technology and be transferred to the analysis software immediately. Billings, calculations or other analyses can be performed in a timely manner; processes can be monitored and controlled actively. This saves time and ensures the data quality and immediacy required.

Datafox data terminals are based on the Datafox Embedded-System which is equipped with modern technology for data collection and of course also data transfer. You make your entries comfortably via keyboard, touch display, RFID or barcode. The device is available with GPS, GSM, GPRS, USB etc. It fulfills all conditions for a flexible usage not only for personnel or order time recording but also for further scopes. This constitutes a real added value. The powerful tools DatafoxStudioIV and DLL facilitate quick and easy integration in any IT solutions. Due to scalability, numerous options are available. You can select according to your company's requirements and only pay what you really need.

2.1. Structure of the Documentation

The manual contains a change history as well as a general part with safety information, the introduction and information concerning system requirements and system structure.

The general part is followed by the main part of the manual. It contains the chapter Product Description Device. In this chapter, device-specific components are described as well as the device's functions.

The final part of the manual provides technical data about the device and a glossary whose purpose it is to ensure a consistent understanding between user and manufacturer.

2.2. Guarantee Restriction

All installers are responsible for the use of the device and its accessories in accordance with its intended purpose and in compliance with the applicable laws, standards and directives.

All data in this manual has been checked carefully. Nevertheless, errors cannot be excluded. Therefore, we offer no guarantee nor accept any liability for consequences that derive from errors of this manual. Of course we are grateful if you point out errors to us. We reserve the right to make modifications in respect of technical progress. Our general terms and conditions of business apply.

Note:



Due to DatafoxStudioIV, Datafox devices offer many functions and combinations of functions not all of which can be tested in the case of updates. This applies especially to setups defined by you as customer. Before updating your device, please ensure by tests that your individual setup works without any errors. If you encounter a problem, please inform us immediately. We will take care of the clarification of the problem on short notice.

2.3. Typography of the Documentation

FW	Abbreviation for firmware (software in the device)
SW	Abbreviation for software
HW	Abbreviation for hardware
GV	Abbreviation for global variable
<Name;Software Version.pdf>	File names



Note:

Useful information which helps you avoiding possible mistakes during the installation, configuration and commissioning is given here.



Caution:

Here, notes are provided which must be strictly observed. Otherwise, malfunction of the system will occur.

2.4. Important General Notes



Caution:

Use the devices only according to regulations and follow the installation, commissioning and operating instructions. Installation and commissioning may only be performed by authorized specialists.

Subject to technical alterations.



Caution:

Due to technical development, illustrations, function steps, procedures and technical data may vary slightly.

The Datafox device has been developed for the purpose of creating a flexible and easily integrated terminal for data recording serving for a great variety of applications. The device is robust and easy to use. Due to the PC setup program, the device is quickly and easily configured for its application field so that you save time.

Numerous optional features, such as bar code reader, transponder reader, digital inputs etc., enable you to use the device for:

- PZE - Personnel time recording
- AZE - Order time recording
- BDE - Operating data recording (I/O-processing)
- ZK - Access control
- FZDE - Vehicle data recording / telematics

This manual describes the creation of setups with the setup program DatafoxStudioIV without covering specific applications. Potential problems and difficulties are pointed out.

This manual describes the functionality of the EVO 3.5 Universal and explains its characteristic features. For example, installation, operation and equipment of the device are described.

In order to define the behavior of the device, a setup must be created. For this purpose, the DatafoxStudioIV has been developed.

With some practice it will be possible to create a complete compilation for the EVO 3.5 Universal within half an hour. If you need functions that are not available, please contact us.



Note:

If you need support for the compilation of setups, we offer you our services. Due to our extensive experience with the setup, we work very quickly and can make your setup even more efficient through useful advices, so that the input at the device can be performed quickly and securely.



Note:

Due to DatafoxStudioIV, Datafox devices offer many functions and combinations of functions not all of which can be tested in the case of updates. This applies especially to setups defined by you as customer. Before updating your device, please ensure by tests that your individual setup works without any errors. If you still encounter problems after thoroughly testing your setup, please inform us immediately. We will fix the error on short notice.

3. Intended Use and Environmental Protection

3.1. Regulations and Notices

According to the current state of the art, measures were taken to ensure that the device meets the technical and legal regulations as well as safety standards. Nevertheless, malfunctions due to interferences through other devices can still occur.

Please observe local regulations when using the device.

3.2. Power supply

Only operate the device externally with a limited power source in accordance with EN 60950-1.

If the devices run with rechargeable batteries, note the instructions in chapter "Rechargeable Battery".



Caution:

In the event of non-compliance with these instructions, the device or the battery (if any) can be damaged or destroyed!

In order to ensure maximum battery life, it is recommended to recharge the battery only after complete discharge.

See respective type label of the device EVO 3.5 Universal.

3.3. Environmental Influences

Extreme environmental influences may damage or destroy the device and should be avoided. This includes fire, extreme sunlight, water, extreme cold and extreme heat.

See respective type label of the device.

3.4. Mounting outdoors

3.4.1. Temperature

The device has an approved temperature range of - 20 ° C to + 70 ° C.

A heater is not necessary for outdoor use.

Due to the inherent heat of the electronics and power supply, the temperatures in the unit are higher even at ambient temperatures below -20 ° C.

Condensation water only occurs when a cold object comes into the heat and would therefore only be an issue for mobile devices.

We recommend, if you use the devices outside, then let it running permanently. Both in terms of temperature as well as condensation, it is recommended to not switch off devices which are used outdoors.

3.5. Repair

Except for the battery replacement in mobile devices, Datafox devices are maintenance-free and must only be opened by authorized professionals. In case of defects, please contact your dealer or the Datafox service hotline.

If a definite defect is present, you can also send the device directly to Datafox.

https://www.datafox.de/reparaturen.de.html?file=files/Datafox_Devices/PDF/Support/Datafox%20Reparaturbegleitformular%20V3%2C%20D-GB_2020.09.25.pdf

3.6. Cleaning



Never use scouring milk or caustic cleaning agents to remove dirt. Especially the displays as well as the keyboard and fingerprint modules must be cleaned carefully.

Wet wipes are permitted with:

- Water
- Soapsuds
- Glass cleaner
- Sagrotan
- antifact® N liquid (disinfectant for devices in medical field).



CAUTION

Risk of explosion if batteries are replaced improperly.
Dispose used batteries according to the instructions.

3.7. Further Notices

Do not expose the device to strong magnetic fields, especially during operation.
Operate the slots and connections of the device only with the appropriate intended equipment.
Ensure that the device is secured during transport. For reasons of safety, do not use the device while driving a vehicle. Also ensure that technical equipment of your vehicle is not compromised by the device.
In order to prevent SIM card misuse, have your SIM card blocked immediately in cases of loss or theft of the device.

3.8. Disposal

Observe local regulations concerning the disposal of packaging material, used batteries and scrapped electrical equipment.

This product complies with the EU Directive No. 2002/95/EC, its appendices and the Council Decision laying down the restrictions of the use of hazardous substances in electrical and electronic equipment.

The device is covered by the European Directive on Waste Electrical and Electronic Equipment which came into force on February 13, 2003 and was translated into the legislation of the Federal Republic of Germany on August 18, 2005.

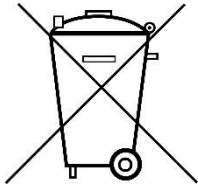

Do not dispose the device in domestic waste!

As the user, it lies within your responsibility to dispose electrical and electronic equipment via the designated collection facilities. The correct disposal of electrical and electronic equipment protects human life and the environment.

For more information regarding the disposal of electrical and electronic equipment, please contact your local authorities or waste disposal companies.

3.9. General Hardware Information

3.9.1. Hardware equipment

The devices with hardware V4 are equipped with a flash memory. Depending on the device type or selected option with 4 or 16 MB.

For the data, the memory is used as a quasi-ring buffer. If the complete ring buffer is written to full without the data being retrieved, the terminal reports "Memory full", please notify the admin". No further data is stored during this time.

Data that has already been read is gradually transferred. The entire memory is always used to minimize the number of accesses per individual memory cell.

An ARM microcontroller with 32-bit technology is used.

Depending on the type of device, the device has a Goldcap capacitor for buffering the time. This ensures that the watch continues to run correctly for up to one week if the power supply is interrupted.

In other devices, such as EVO 4.3 or PZE-Master V4, a buffer battery is installed in addition to the capacitor. With this, the watch retains its value for approx. 4 years.

The exact equipment can be found in the last chapter Technical Data.

3.9.2. Behavior in case of power failure

The device boots automatically when the power supply is switched on again.

All data that was not sent or retrieved by the application software before the power failure is stored on the device.

These are not lost. After booting, this data is available again.

3.9.3. UPS

A corresponding UPS for the V4 hardware is in preparation.

We currently recommend equipping the devices with a POE module if a "UPS" is to be used. Then connect the devices via a POE switch and supply the switch via a standard UPS.

4. System Requirements / Hardware

4.1. System Structure

The system consists of the Datafox device, the DatafoxStudioIV, the communication DLL and a software for processing the generated data.

Create setup

Save setup

Transfer setup to device

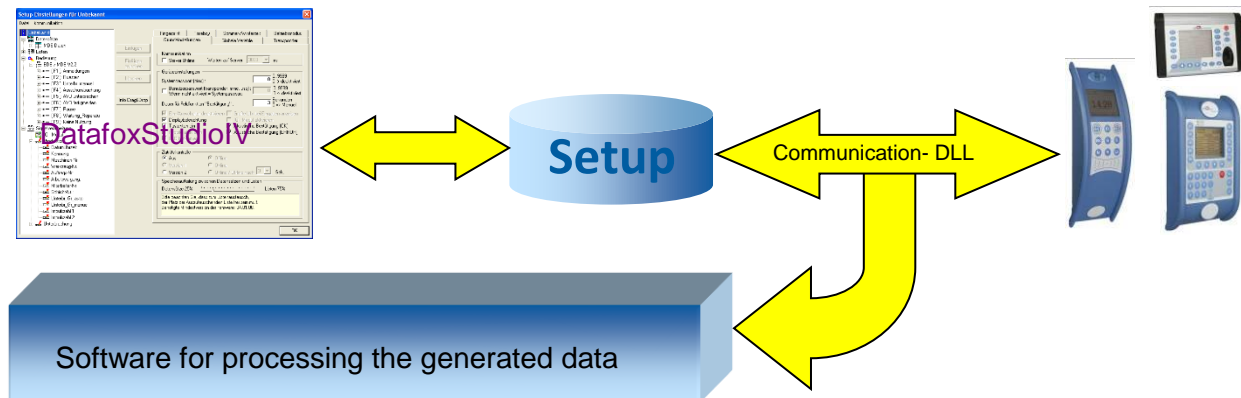

4.2. Requirements for Operating Datafox Devices

In order to operate the Datafox device, you need a 230 V power connection for the Datafox power supply. Depending on the main communication set, you need a corresponding transfer medium or connection cable.

Main communication:

- USB → one standard USB-A to USB-micro Cable (see the chapter connection USB).
- RS485 → a transmission path in accordance with the EIA-485 standard (see Connection RS485).
- GSM/GPRS → a distortion-free mobile connection (see Connection GSM).
- WLAN WiFi → a distortion-free channel to an access point (802.11 b/g) within reach (see Connection WLAN).
- at least one standard Ethernet cable, no „cross over“ (see Connection TCP)
- HTTP (internet) via LAN → TCP/IP connection with free internet access. The data are sent to a server.



Note:

With increasing demands on transfer rate and interference immunity, the demands on the transmission path increase as well with regard to quality (interference immunity).

4.3. Compatibility

The compatibility must be observed urgently between:

- Datafox devices and the device firmware
- Device firmware and device setup
- Device firmware and communication DLL
- Communication DLL and DatafoxStudioIV
- DatafoxStudioIV and device setup

4.3.1. Firmware File Archive (*.dfz)

Description

Device files (*.hex) of the MasterIV devices are delivered in a common firmware file archive. It has the file extension DFZ (stands for Datafox Zip). Now simply the firmware file archives (*.dfz) are indicated instead of the device files (*.hex). This applies to the DatafoxStudioIV and the DLL. The indication of device files (*.hex) is still possible.

Function of the Archive

The transfer routine of the device file selects the right file from the firmware file archive on the basis of the hardware options available in the device. Thus, it is guaranteed that all hardware components available in the device are supported by the corresponding firmware.

Manual Selection of a File

If you do not want to integrate the archive in your installation, you have the possibility to add single device files from the archive to the installation.

The file format of the firmware file archive is ZIP. Hence, you can open the archive with every standard ZIP-program. Via the entry "Open With" in the context menu you can select an appropriate program for opening the file. If necessary, you can call up a program combined with this file format to open the file by renaming the file from DFZ to ZIP.

In the archive you find a file named "Inhalt.pdf"; it contains information which file (*.hex) of the archive matches your device. Extract the desired device file (*.hex) and rename it if necessary. A renaming of a file is possible at any time, because all information are in the file itself.

You can state the device file extracted before as device file in DatafoxStudioIV and at calling the DLL function. It is still tested if the file can be loaded into the chosen device before the transfer takes place.

4.3.2. Datafox Devices and Device Firmware

Each Datafox device has an electronic flat module. The module has specific hardware equipment concerning the options (e.g. mobile radio, WLAN, fingerprint, ...). Due to technical conditions, different options are mutually exclusive. Currently, not all hardware options can be supported in one firmware file due to limited program memory. This means that each device with specific hardware options needs a proper firmware to support the hardware options by the software.



Caution:

Hardware generation V 3 is supported from version 04.02.00.x onwards. The DatafoxStudioIV is compatible up to and including firmware version 04.01.x.y. Older versions 04.00.x.y are not supported any more.

4.3.3. Device Firmware and Device Setup

The firmware (operating system) of the device and the device setup (*.aes data file = application program) form a unit. By the device setup, the runtime behavior of the device (the firmware) is determined. This means the response of the device to input events by the user or the environment (e.g. digital inputs). In principle, only those functions of the device are executed that are supported by the firmware and defined via the setup. Prior to the productive commencement, you should therefore test each setup with the corresponding device or on a device with the same hardware options and firmware.

4.3.4. Device Firmware and Communications DLL

A firmware supports certain functions, dependent on the hardware options. The communication DLL is the interface between the firmware and the DatafoxStudioIV or your processing software. Therefore, the firmware must always have the same or a lower version number as the communication DLL.



Note:

If your application uses a newer version of the DLL than the firmware does, you can only use functions that are supported by the firmware. Otherwise, you will receive an error message (e.g. function not supported) which has to be analyzed.

4.3.5. Communications DLL and DatafoxStudioIV



Note:

The DatafoxStudioIV and the communication DLL are developed and released as a bundle. Therefore, they have to be used as a bundle. A newer version of DatafoxStudioIV does not work with an older DLL.

4.3.6. DatafoxStudioIV and Device Setup

With the DatafoxStudioIV, you create a device setup (application program) for the Datafox device. That means that in the setup only those functions were defined which were available in the DatafoxStudioIV version at the time of the setup creation. The DatafoxStudioIV you use for opening a device setup may thus only be newer but never older than the DatafoxStudioIV version you used to create the device setup.



Note:

The updates are always available for download on our homepage www.datafox.de.



Caution:

When new devices are delivered, the latest firmware is loaded on the devices. If you wish to work with an older firmware version, please perform a downgrade. Please observe the compatibility notes in the release notes of the respective firmware version.

The data file <Device name>, Software version <version number>.pdf shows which functions are supported by which software release.

You will find the file on the product CD. Please also follow the instructions given in the chapters of the manual.

4.3.7. Update / Downgrade

A firmware update or downgrade is a very sensitive process. Possibly, a reset of the main communication to RS232 may occur. In any case, consider the information regarding the compatibility in the software version list.

Firmware Update



Caution:

Before starting a firmware update, please check on the basis of the software version list whether there are any version dependencies that must be observed.

For example: when changing from Version 04.00.xx to version 04.01.xx, at least version 04.00.23.769 or higher must be present in order to run the update to version 04.01.xx successfully.

Firmware Downgrade

A firmware downgrade is not recommended.

We are constantly working towards improving the software/firmware; all functionalities are still included in new versions. New software always offers better functionalities and possible bugs are fixed.



Caution:

When performing a firmware downgrade the firmware has to be transmitted to the device twice. This has technical reasons. Errors shown on the display of the device after the first transfer can be ignored.

5. Device

**Note:**

It has to be taken care of a suitable protection from direct sunlight because the synthetic materials are not 100% UV resistant. Fading simply is an optical defect which does not restrict the function of the device.

**Caution:**

Please keep in mind that MasterIV terminals use a flash memory. According to the manufacturer each memory sector (512 byte) can be written to a maximum of 100,000 times. The firmware of the terminals distributes the access to the memory sectors, this technique is called wear levelling. Bad blocks in case of write or read failures are not used anymore. However, despite this technique it is not advisable to write the memory too frequently. The application should initialize a new list transfer only after a change of the list data but not cyclically.

Keep in mind the message - FlashService - in the display of the device. It means that the live time of the flash memory according to the manufacturer instruction will be reached soon. Then the device has to be sent to Datafox for service.

5.1. Commissioning

On delivery, the device is fully functional and configured with a demo setup so that you can test the input immediately. After establishing the power supply the device will switch on automatically. The EVO 3.5 Universal automatically starts booting, recognition of the hardware options and loading the setup. After having finished booting, the device switches to operation. Now itEVO 3.5 Universal is ready for use.

**Note:**

On delivery, the main communication is set to USB.

**Caution:**

If external modules (e.g. access control, signal processing via the digital inputs) with an external power supply are used, ensure to comply with all limits (max. voltage and current) before commissioning the system.

5.2. Guideline for Commissioning

5.2.1. Set-up of the device

This section provides a short guideline for commissioning und links to the corresponding chapters in the manual.

- ▶ Connecting device to current supply
- ▶ Setting interface for communication
- ▶ Loading setup of the device See manual „[DatafoxStudioIV](#)“

5.2.2. Installation of the Device

- ▶ Installing the device at the intended location
- ▶ Establishing connections for:
 - Power:
 - Communication:
 - [USB](#)
 - [TCP/IP](#)
 - [TCP/IP wLAN /Wi-Fi](#)
 - [GPRS](#)
 - [RS485](#)
 - [Digital input](#)
 - [Digital output](#)
 - [Analog inputs](#)
 - [Access-control](#)
- ▶ Finishing installation of the device
- ▶ Setting for man communication

5.2.3. Troubleshooting during Commissioning

- ▶ Please see the FAQ on our website: <http://www.datafox.de/faq-de.html>.
- ▶ Tips:
 - Connection to the device cannot be set up via TCP/IP
 - Check IP in the device and the application (studio)
 - Ping on IP
 - Setting "Active Connection" in BIOS? → set to NO
 - Setting "HTTP" in BIOS? → set to NO

5.3. Operation and display elements of the Evo 3.5 Universal

5.3.1. Composition and Operation EVO 3.5 Universal

The terminal includes a capacitive touch.

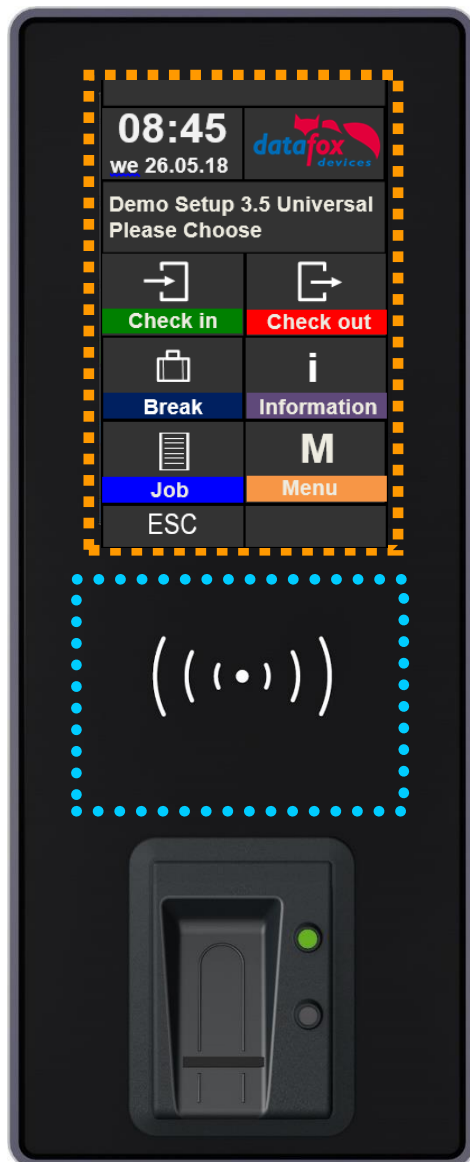

display and touchsector

read sector for transponder

5.3.2. Display setup and bios of the EVO-Line 3.5

5.3.2.1. Structure display "normal display" 3.5 Universal

The entire display surface is provided with a touch. Just tap with your finger on the tile you want to select.

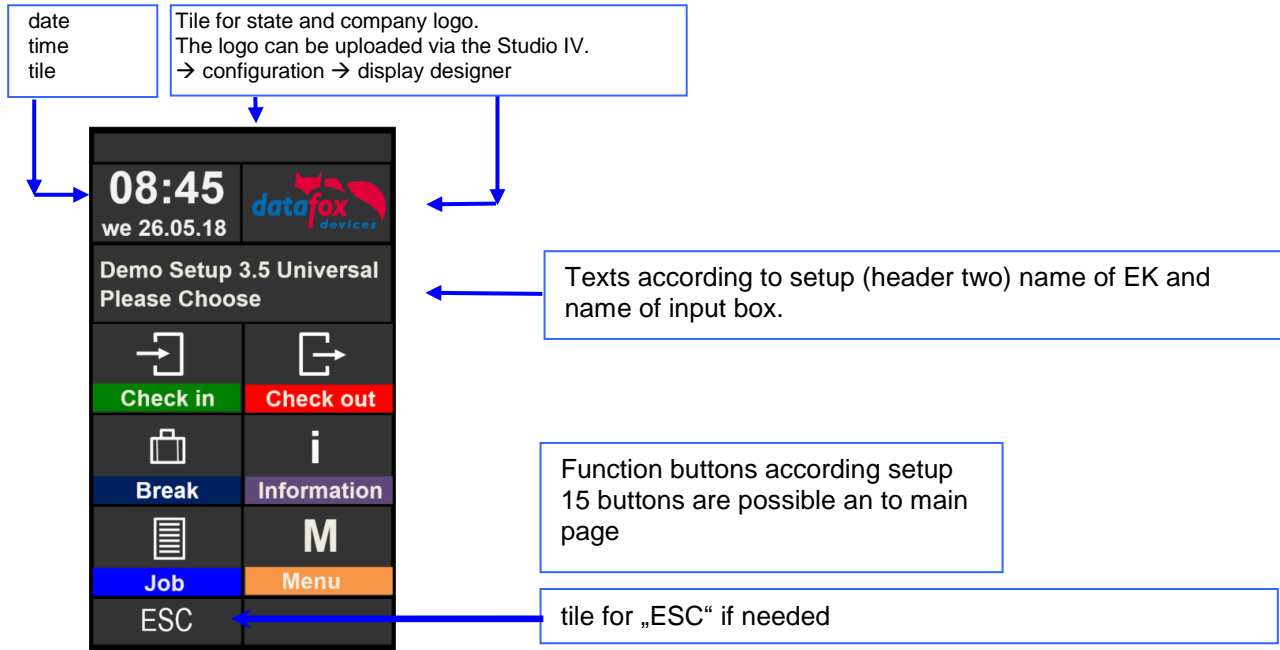

- **Date Time** corresponds to the system time of the device, which is also used for the data records.
- **Number of records** in memory (display up to 99, then 99+).
- **Communication** field with symbols for:
 - **TCP /IP** When this communication is active, this symbol is displayed. **TCP /IP** ↓↑
 - **Wlan communication**
 - WLAN as main communication
 - Wlan connected
 - ↓↑ Wlan Communication is currently active
 - signal strength wifi
 - **USB**
 - **USB Host** (Save the data to USB stick)
 - **RS 485**
 - **GPRS** With status display e.g.[33] See "Status messages on the display".
 - Mobile modem is off
 - Mobile modem is switched on, but no connection to the provider.
 - Mobile modem is switched on, connection to the provider exists.
 - **Mobilfunk** (BG-96 und EG-95), status display e.g.[33]] See "Status messages on the display".
 - Mobile modem is off
 - Mobile modem is on, but no connection to the provider.
 - Mobile modem is on, edge connection to the provider.
 - **3G** , **H** , **H+** , Mobile modem is on, 3G connection to the provider..
 - **LTE** , **MI** , **NBI** , Mobile modem is on, LTE connection to the provider.
- **Display on the display**
 - The header lines 1 and 2 of the setup are displayed in the main menu.
 - The header lines 3 and 4 stored in the setup are displayed in menus and input chains.
 - During the transmission of a setup or firmware update, the device enters the system stop and displays this symbol „ Systemstop“ in this window.
 - Display in the left part of the window:
 - = Transponder input (Accept value of transponder)
 - = Check in (coming) - booking
 - = check out (going) - booking

5.3.2.2. Structure Display EVO 3.5 Universal in the Bios menu

You get into the bios menu when you press the tile **company logo for two seconds**.

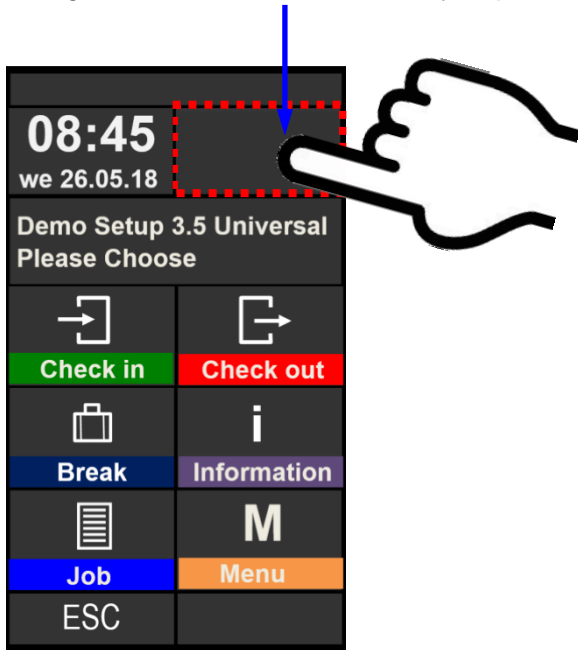

Display of the status icons:

Tap the logo briefly to display the status icons. You can also change the display of the icons in the user settings to:

- Constantly in place of the logo
- Constantly in the "ESC" tile
- For 60 seconds instead of the logo
- off

Display in Bios Menu:

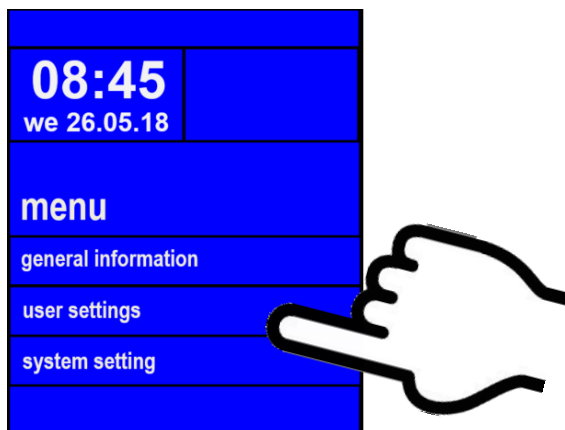

To select each menu, simply tap on it with your finger.

If a bios password is set, you are able to enter it here.

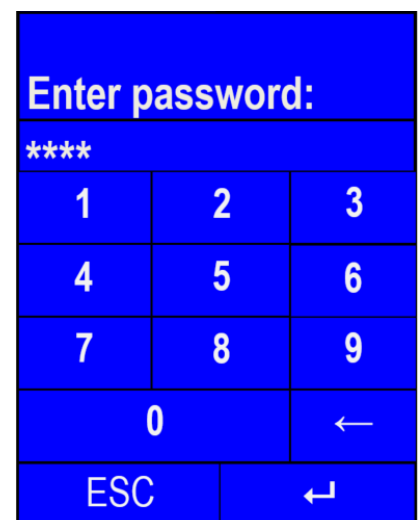
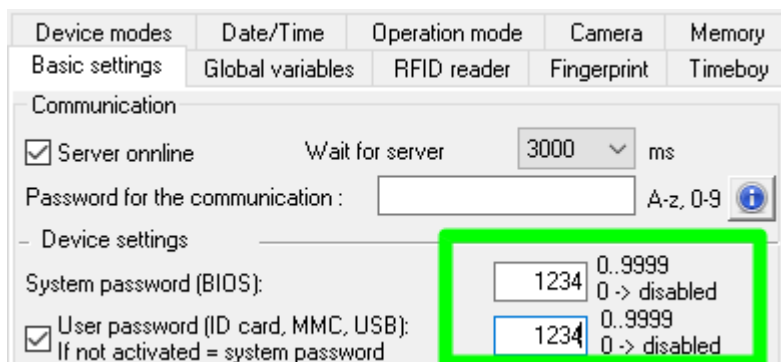

System menu bios:

08:45 we 26.05.18	
menu	
general information	
user settings	
system setting	
ESC	

The respective submenus should be self-explanatory. The respective display depends on the hardware equipment.

08:45 we 26.05.18	
general information	
firmware information	
no message	
RFID test-menu	
memory usage	10 k Byte, (5%)
record memory	512 k Byte
list memory	512 k Byte
ESC	

Communication setup: (system menu bios)

communication	
interface	LAN
Active Mode	no
HTTP-Mode	no
LAN-Parameter	

- Select here the interface for the main communication.
- parameter for active-mode (standard = no)
- parameter for HTTP (standard = no)
- settings of the TCP/IP parameter (IP-address)

TCP / IP / DHCP - settings:

08:45	
Mi 26.05.18	
LAN-Parameter	
MAC	E4-7F-1A-00-02-CC
DHCP	Nein
IP	192.168.101.225
Netmask	255.255.255.0
Gateway	192.168.101.1
Port	8000
ESC	

If in the device DHCP (yes) is activated, you aren't able to change the IP-address. The IP assigned by the server will be displayed.

TCP / IP - settings:

IP – set

LAN-Parameter	
MAC	E4-7F-1A-00-02-CC
DHCP	Nein
IP	192.168.101.225
Netmask	255.255.255.0
Gateway	192.168.101.1
Port	8000

IP		
192.168.101.225		
1	2	3
4	5	6
7	8	9
0		←
ESC		↵

Transponder menu

Menu	
Type	Mifare
Version	38022I

In the transponder menu you can see which transponder is installed and which version it has. (In this example: Mifare and 38022I)

Some settings to write the transponders must be adjusted in the setup.

Device modes | Date/Time | Operation mode | Camera | Memory
 Basic settings | Global variables | RFID reader | Fingerprint | Timeboy

RFID reader type : **Hitag2**

Selecting segments for reading

Segment No.	Storage format	Fixed length
1. 4	Dec (max. 15 digits)	no
2. no	Dec (max. 15 digits)	no
3. no	Dec (max. 15 digits)	no

Note: For a fixed field length is filled with leading zeros.

Write ID Card

Start value 1: Autoincrement

Start value 2: Autoincrement

Start value 3: Autoincrement

Autoincrement value for all:

Password for ID cards (default: 4D494B52)
 Password in hexadecimal (max. 8 characters):

name	meaning
transponder type	Here, the correct transponder type must be specified
segment no.	In which segment should be written / read
starting amount	Defines the starting value of the number to be programmed
autoincrement	When activated, the programming value always counts up the final number
password	The password to write / read the ID



Note:

If IDs are to be written with a password, the password must first be programmed on them.

Attention:

In the setup a programmable transponder type and a programmable segment must be set. Ex.:



- Hitag 2 -> from segment 4
- Mifare Classic -> from sector 0 block 1

Otherwise, only the type and version of the transponder reader will be displayed.

Signal volume:

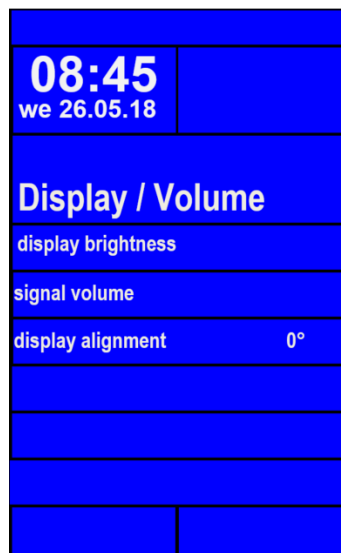

This menu can be found under "user settings" → "display / signal volume".
→ "signal volume"

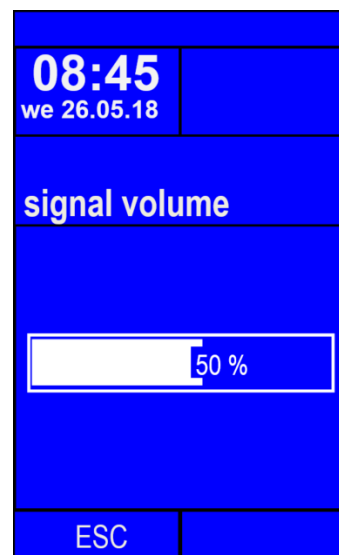

Touch-Test:



This menu can be found under „user settings“ → „touch“.

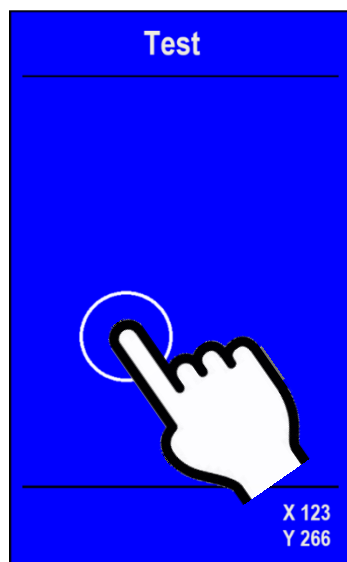

Here the correct function of the touch screen can be checked.

To exit the menu, hold down on the display with two fingers for three seconds.

5.4. Installation of the 3.5 Universal

The wall mounting takes place by means of a wall bracket. We recommend the mounting over a switch box and additional fix with 4 screws.

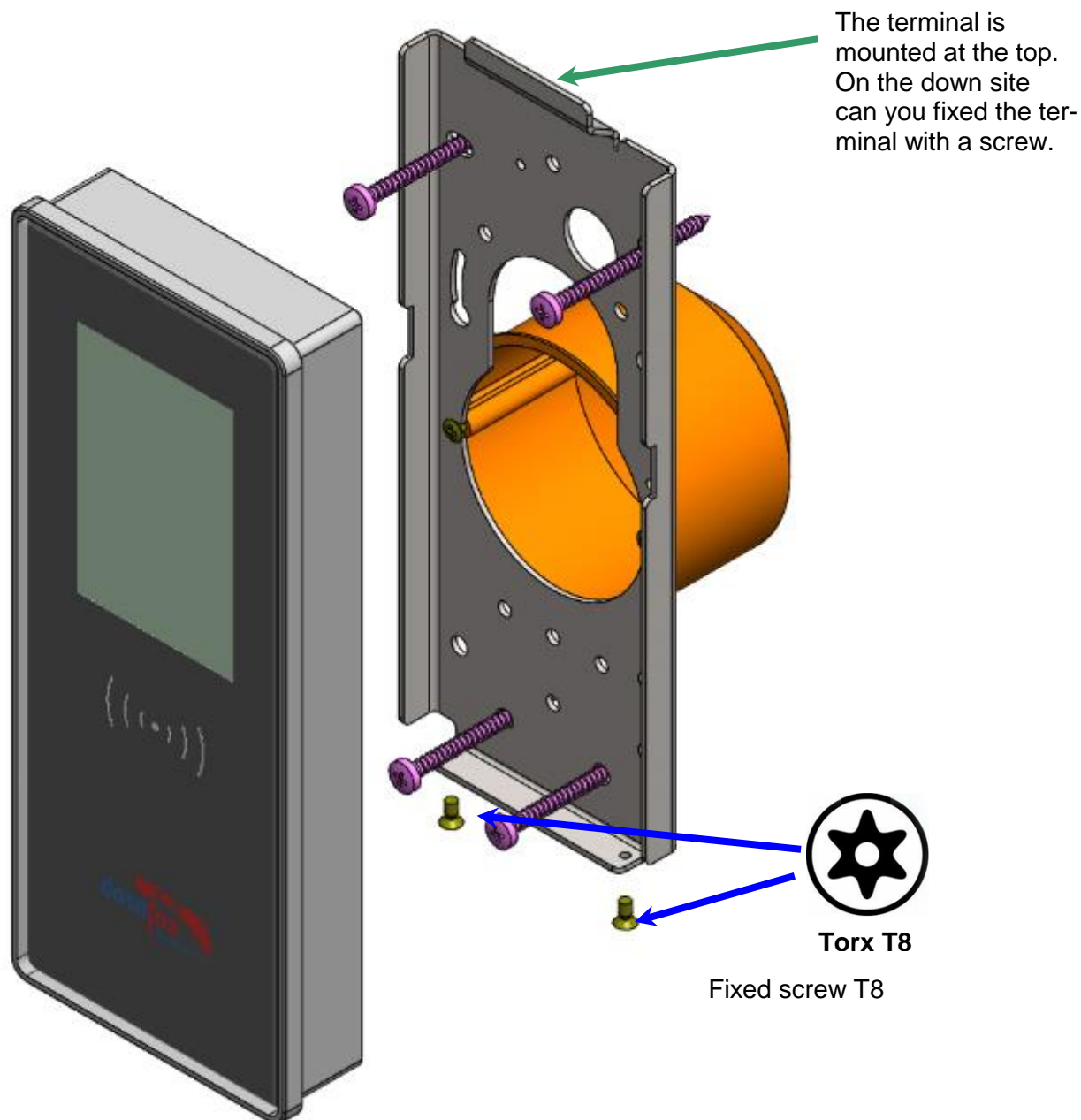

5.5. Connecting of KYO Onleloc and EVO 3.5 Universal

The KYO Onleloc / Universal is connected via three clamps.

- One plug for the TCP/IP connection
- One plug for the access control connection
- A connector for the RS485 bus

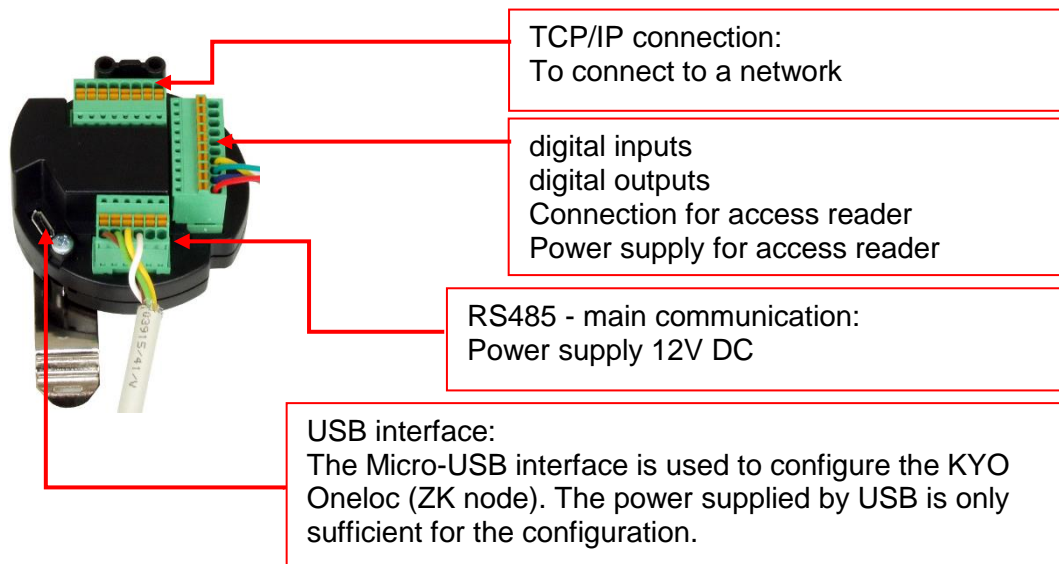

Note:

Please note that the RS485 bus must not be wired in a star configuration. No stub lines are supported either.

Explanation:

- - Power supply 12V: terminal 3, pin 1 + 2 or via POE
- - ZK 485 stands for access bus RS485
- - HK 485 stands for main communication RS485
- - Voltage output for access control-Bus: terminal 2 pin 1 and terminal 2 pin 2
- - DigOut active, e.g. for electric door openers:
 - a) Configuration to 12V, max. 500mA,
Terminal 3 Pin 5: 12V switched, terminal 3 Pin 6 Ground permanent
 - b) Configuration to GND (open drain) max. 30V, 2.0A,
Terminal 3 Pin 5: GND switched, positive voltage external or via terminal 2 Pin 1.

clamp 1: 8 pole TCP/IP connector

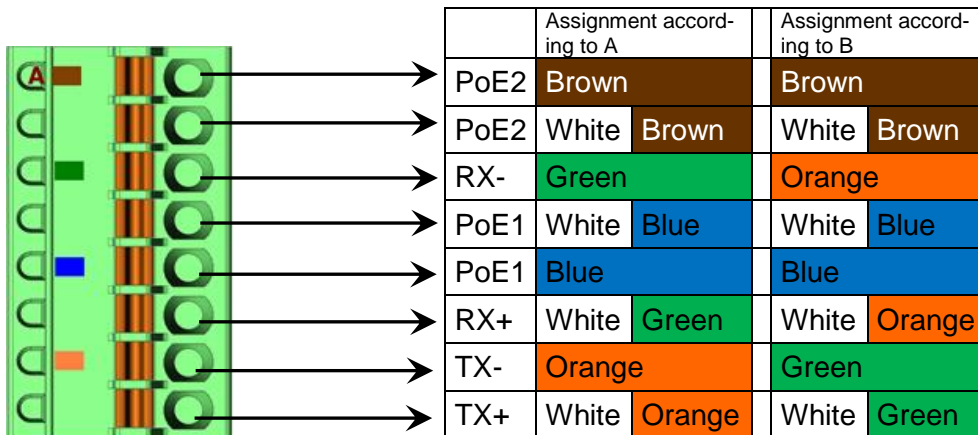

Clamp 2: 10 pole access bus / IO connector

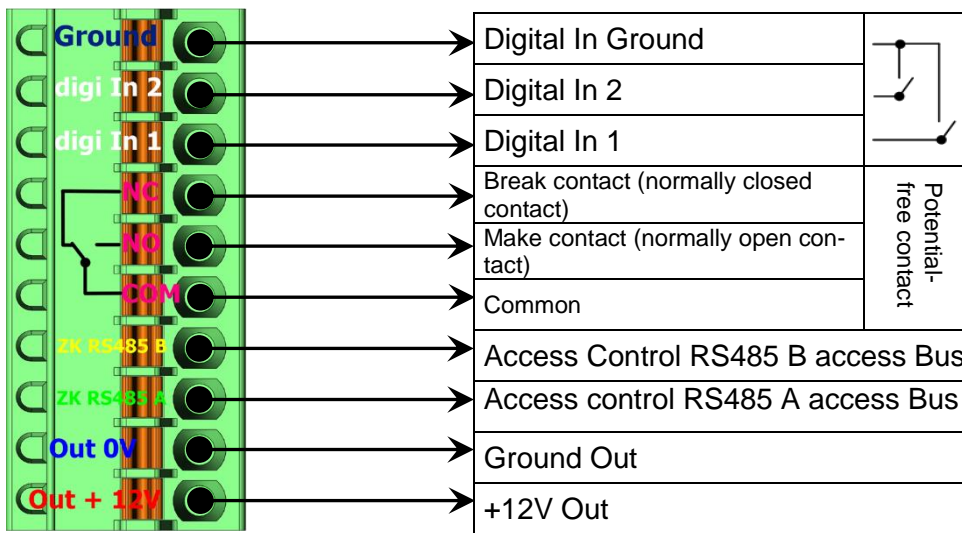

Clamp 3: 6 pole RS485 HK connector

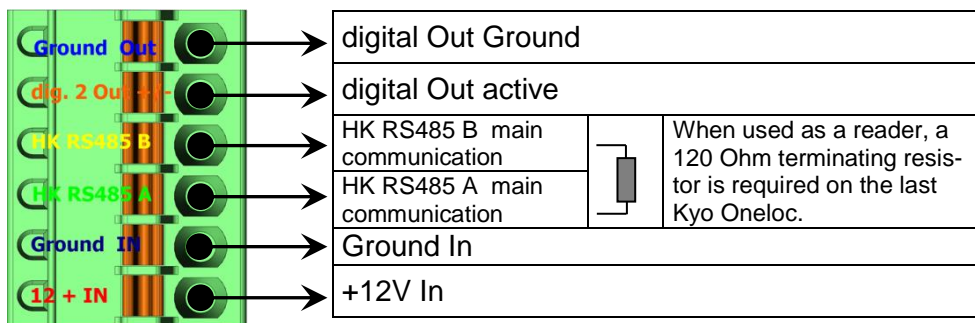

5.5.1. Connection of digital in-/outputs

5.5.1.1. Digital Output one

The digital output 1 is located on the connector strip 2.

This is a potential-free contact.

This can be used via an external voltage source, e.g. as a door opener or connected in parallel to a push-button. A normally open contact (NO) and a normally closed contact (NC) are available.

Connection example 1 with external power supply:

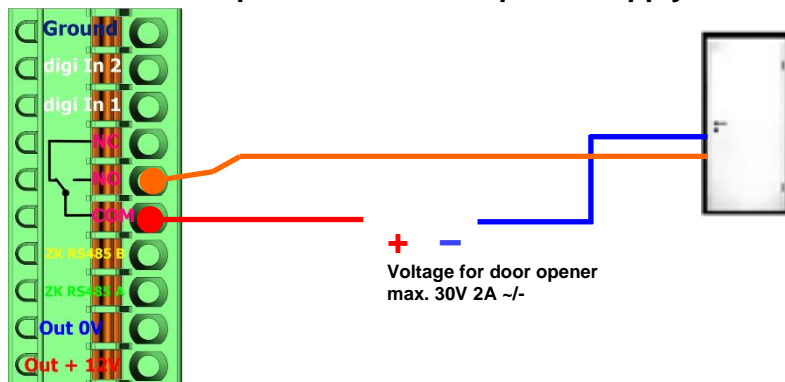

Connection example 2 Parallel connection to an existing pushbutton / connection

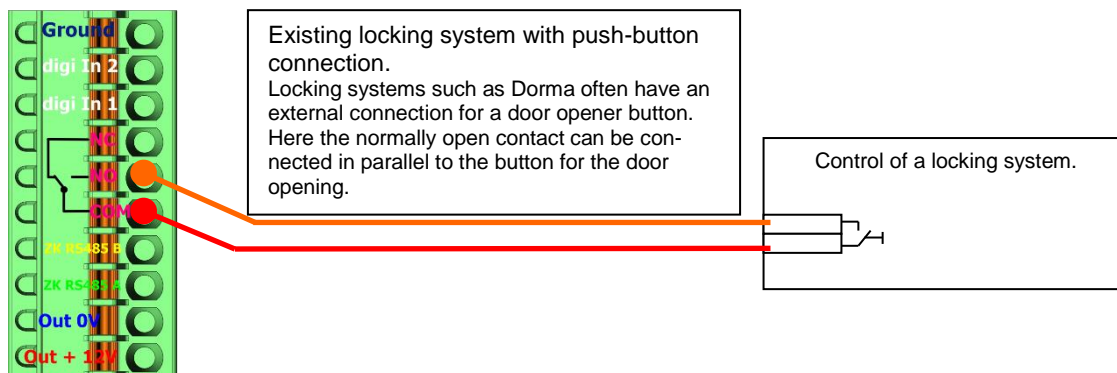

5.5.1.2. Digital Output two

The digital output 2 is located on the connector strip 3.

This is a transistor output.

This can supply either ground or + signal.



Attention:

If power is supplied via POE, this output must not be used.

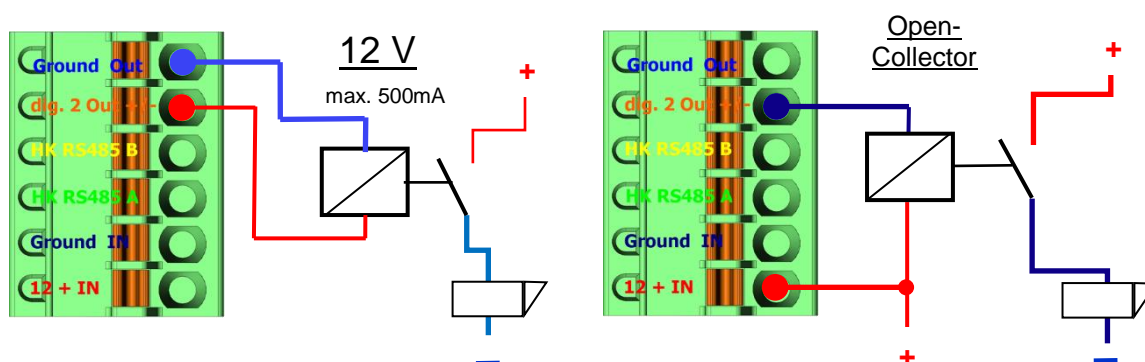

In Datafox StudioIV, the BIOS mode can be used to change the setting between the two methods.

Under Configuration → Device configuration BIOS → Switch to BIOS mode and then under "BIOS" you can switch between "12V" and "Open-Collector".

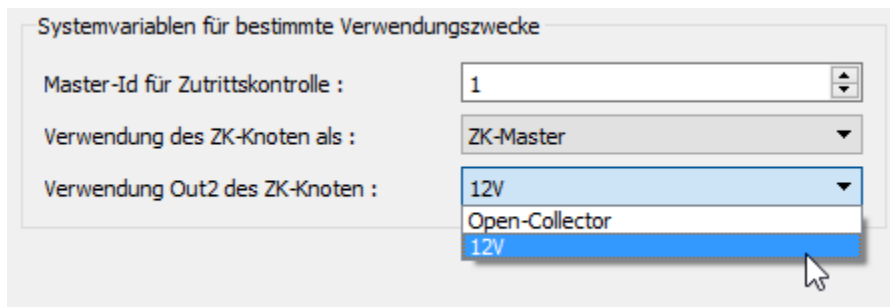

To change the usage

5.5.1.3. Digital inputs

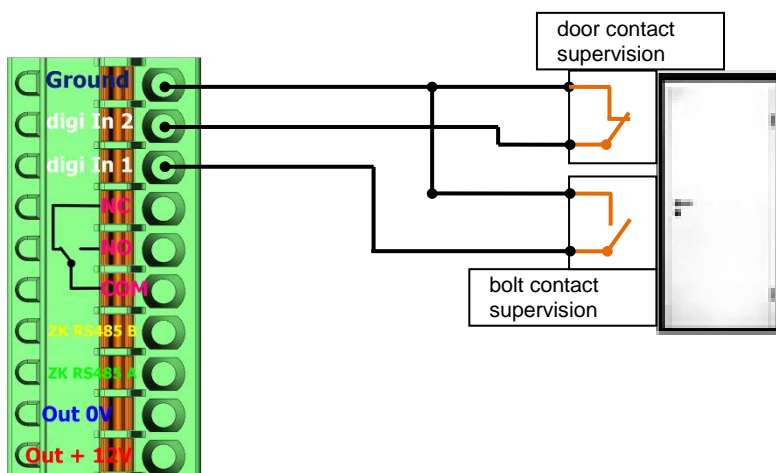

5.6. Communication of Hardware V4 Devices



Caution:

The type of communication depends on the device.
All possible communications are listed in the device.



Note:

Datafox-devices are able to communicate encrypted.
Read more in the manual for the „DatafoxStudioIV“.

The switching of the communication can be done via :

1. the system menu bios on the device
2. with firmware version 04.02.04 and up with the function „Switch communication“.
3. from the Firmware version 04.02.04 upwards with the field function „switch communication“.
Read more in the manual for the „DatafoxStudioIV“

Possible communication types are:

1. USB (on PC)
2. USB Host, Save data on a USB-stick GPRS connection with mobile cell network.

5.6.1. Communication via USB

Every EVO-Line Device is equipped with an USB interface.
The Micro-USB-B Port can be connected directly to a PC.



Caution:

The Terminal works with a USB-B Interface. This means that the device works in slave mode only. So it is not possible for the device to control any other devices via USB.

5.6.1.1. Automatic detected connected USB to PC

If the terminal is connected to a PC it will recognize the connection and will switch the communication to USB.

DatafoxStudioIV will recognize the device and a notification will pop up.

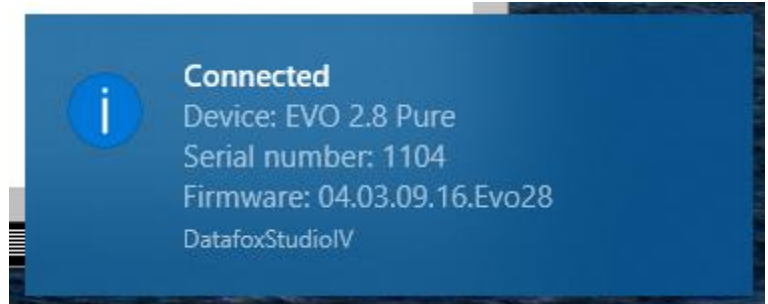

The studio will generate an entry for the device.

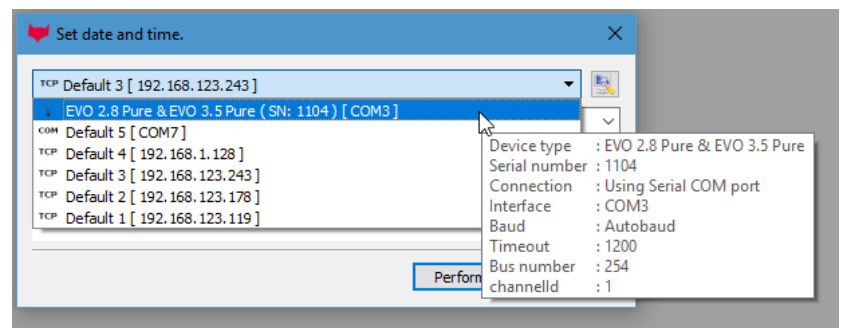

following icon is displayed:



It is not necessary to switch the main communication to USB manually.

It's especially useful for boxed devices.

This will save much time in the parameterizing process.



Note:

If the device is connected to a PC no other connections (for example Wi-Fi) will happen. If the USB-cable is disconnected, it will automatically switch to the configured main communication.

5.6.2. Installing USB driver for Hardware V4 Devices

Installation for Windows 7, 8, 8.1 and 10.

The USB-Driver is a small installer which will do the necessary configuration. Just launch the .exe file.

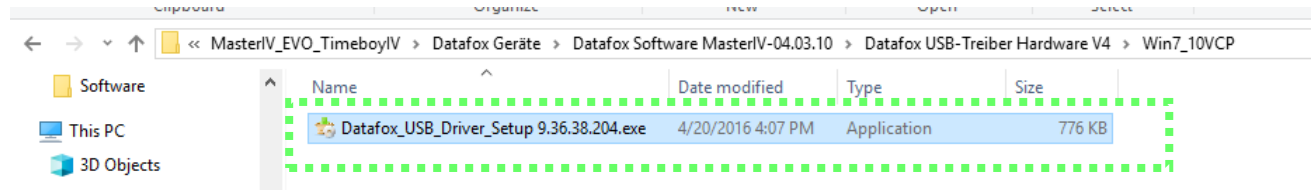

Follow the instructions on the screen:

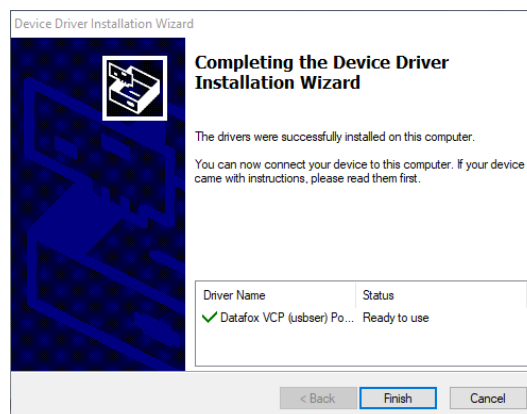
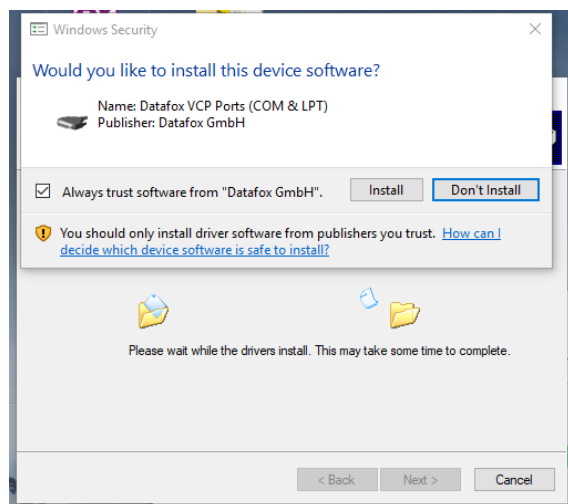
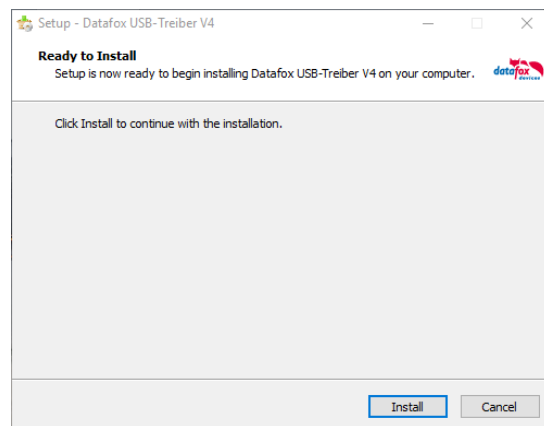
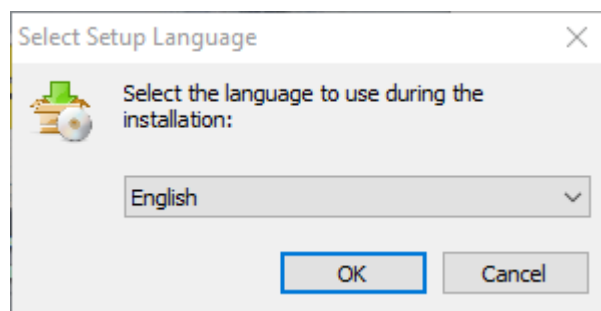

Caution:

Only use the driver which are delivered with the device!



Note:

If you have DatafoxStudioIV installed, the USB-driver will already be installed on your PC.

5.6.3. Communication via TCP / IP

The setting of the LAN / WLAN parameters is done via DatafoxStudioIV under the menu item "Configuration" → "LAN / WLAN – Configuration (*.df0)".

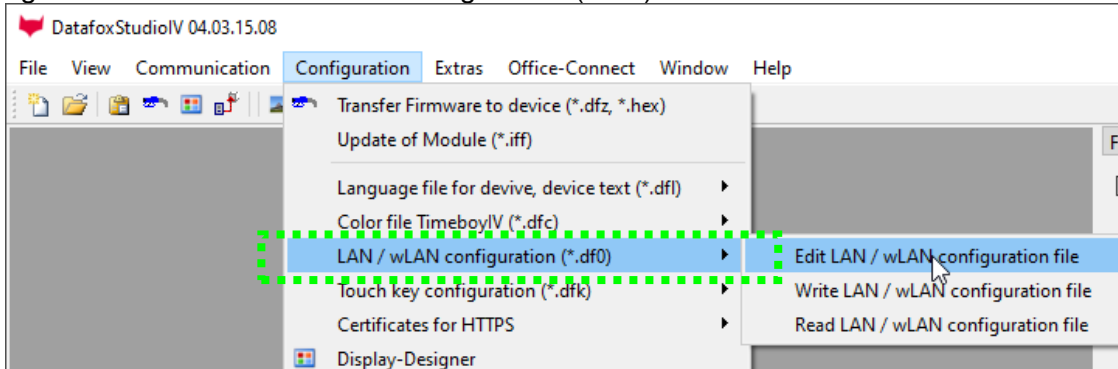

The LAN / WLAN configurations are saved in a file with the filename extension "*.df0". Here you have the possibility to edit the file, load it into the Datafox device (upload) or read it from the device (download).

When reading the WLAN setting from the device, the currently specified file is overwritten.

In the General tab, first of all, you can set the main communication with which the device is equipped.

- Device with LAN (The first configuration is for LAN connection)
- Device with WLAN
- Device with LAN and WLAN (The first configuration is for the LAN connection)

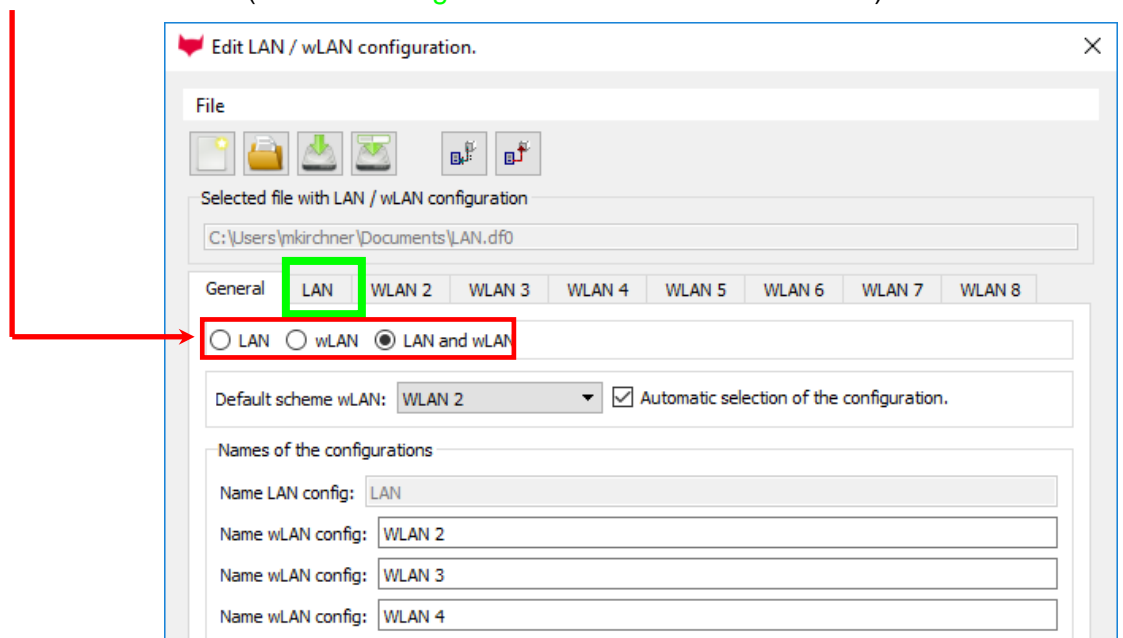

Caution: For TimboyIV only this setting (only wLAN) can be used.

5.6.3.1. Communication TCP / IP via network-cable

You can make the IP settings on the "LAN" tab.

Please enter the desired IP address, subnet and if necessary a gateway.

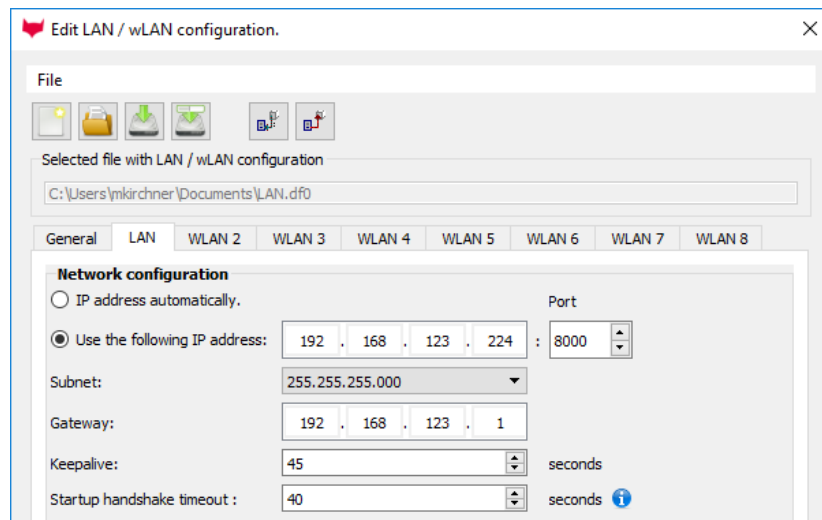

For devices with display, the IP address can also be entered directly on the device. Press ESC and ENTER simultaneously to enter the Bios menu of the device.

More information can be found in the chapter „bios menu“.

5.6.3.2. Communication TCP / IP via WLAN / Wifi

General information about the WLAN modules used.

There are 2 different WLAN modules that have been integrated into the Datafox devices.

- 1.) Redpine – installed in the units since 2013.
- 2.) Texas Instruments TI-CC3135 - installed in the devices since 2021.03.

Basically, both modules can be set via the DatafoxStudioIV or on the device itself. The only difference between the modules is that different standards are supported. You can see what each module supports in detail on the following pages.

You check with the DatafoxStudioIV via Configuration -> Device configuration (Bios):

Standardmodul	014 RS485 + 12V Supply	1	M1	
Standardmodul	012 Digital In-/Output	2	M2	DI 1, DO 1
Standardmodul	WLAN TI CC3135 ML01	4		
Standardmodul	037 Single Serial Port	6		
Transponderleser	TSR32 Reader 125kHz	1		
Standardmodul	014 RS485 + 12V Supply	7	M7	

oder:

Standardmodul	001 WLAN Redpine RS9110 6	-		Vers. 4.5.5, Mac: 88-DA-1A-7F-E6-65, Ip: 192.
---------------	---------------------------	---	--	---

You have a delivery note and look at the article number

- 1.) Redpine: Art.Nr.: xxx112 (generation 1)
- 2.) Texas Instruments CC3135: Art.Nr.: xxx112 A (generation 2)

You are checking the Bios menu of the unit:

Under: System Menu-> System Menu
Bios-> Communication
Here you have to set the unit to "WLAN"
as the main communication.
Under the settings WLAN parameters
you have an info menu „Modul Infor-
mationen“.



5.6.3.3. Texas Instruments TI-CC3135 (Generation 2)

The module is currently not available for the Universal

This overview shows you which **WLAN** methods are supported.

The TI-CC3135 module automatically detects the encryption of the AP. Therefore, only the Security parameter needs to be set. The other parameters (Encryption and Authentication) are detected automatically.

Routers that operate WPA3/WPA2 in mixed mode can already be used now.

If the networks in the 5Ghz and 2.4Ghz bands have the same name, the network with the better reception quality is selected. This is usually the network in the 2.4Ghz band.

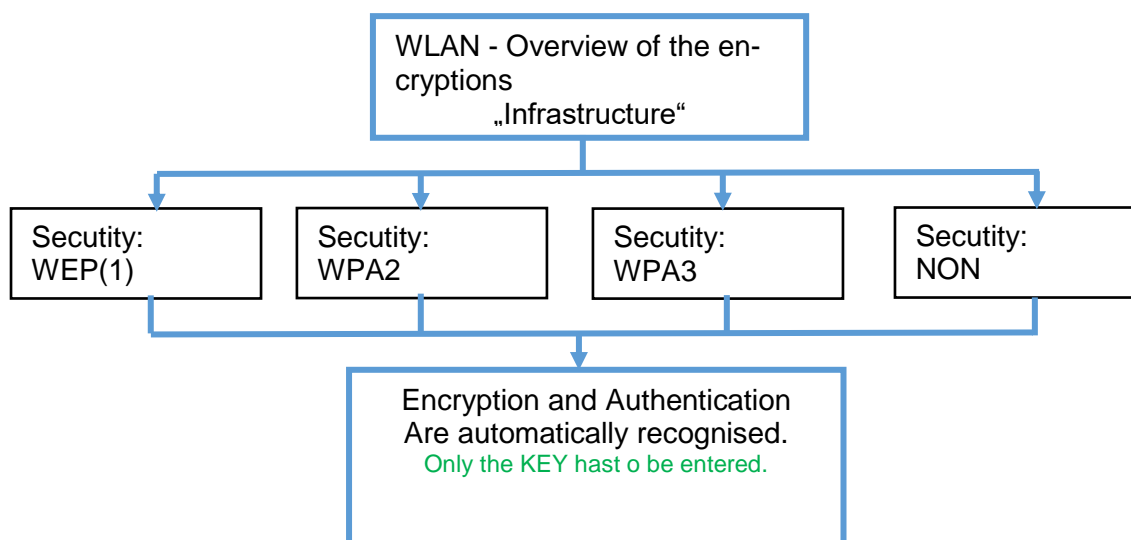

Attention:

We cannot test every Access point on the market. Therefore, it is not possible for us to guarantee a connection to every AP..

Support for WPA3 and WPA2 Enterprise is planned.

5.6.3.4. Redpine (Generation 1)

This overview shows you which WLAN methods are supported.

- **Not supported** is WPA (Predecessor of WPA2).
- **Not supported** is multiple-input multiple-output (MIMO)
- **Not supported** 5 GHz connections and no mixed operation 2.4 GHz / 5 GHz
- **Not supported** Authentication via WPA2 Enterprise according to IEEE 802.1x

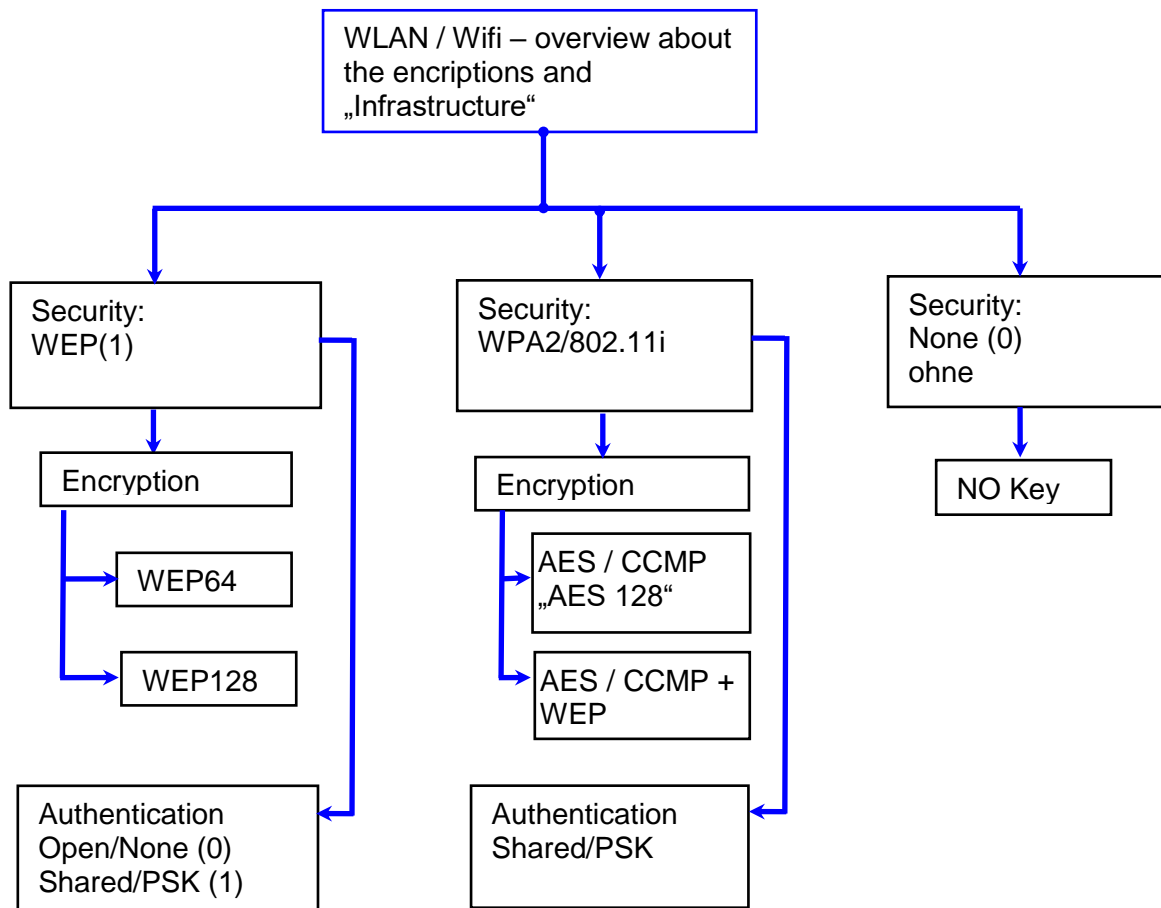

Attention:

We cannot test every available Access-Point on the market.
Therefore, it is not possible for us to guarantee a connection to any AP.



Attention:

[multiple-input multiple-output](#) (MIMO) are not supportet. If you switch the access-Point AP from b/g/n to b/g, use the access-Point only SISO.
https://en.wikipedia.org/wiki/Single-input_single-output_system

When setting the encryption AES or WEP, only one type is used at a time.

The setting AES+WEP means for some access points that AES encryption is performed first and then additionally encrypted with WEP.

In this case, only set AES.

Select the configuration or location for which you want to set the WLAN parameters.

Enter the IP address for the device here. This must be the same for every location.

All the settings required for an access point can be made here.

If a key is stored, this will be displayed.

If you check this box, the battery life will be significantly increased if the device is operated with a rechargeable battery. **Important for TimeboyIV!**

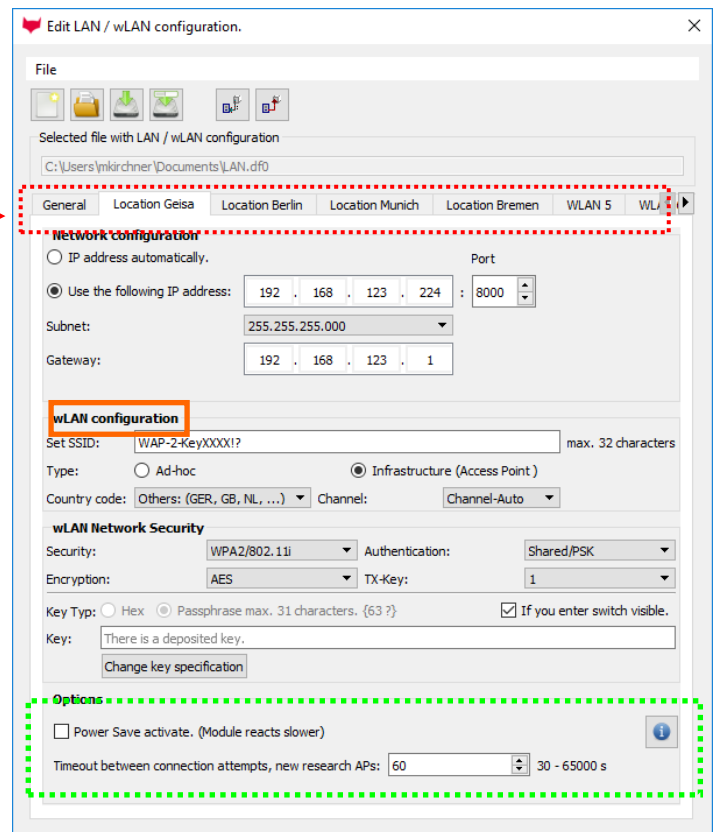

A scan (search) for access points is only carried out after a disconnection after this set time. Please note the following Attention Box!

Attention:

! A search for a new access point requires a lot of energy and drains the battery. Avoid a continuous search for an access point when the device is operating at the limit by generously selecting the pause between scans for new access points (80-120s). At most access points there is the possibility to set the "Beacon Interval". The higher this is set, the less power the TimeboyIV needs. Recommendation: Beacon interval >300ms.

The entire file with all settings is transferred to the device. If the device has a display, the location can be selected in the Bios menu -> Communication -> WLAN. Each location has its own configuration for the WLAN connection. The user therefore has no insight into the dial-in parameters at the various locations.

Hint:

👉 With automatic selection of the configuration / location, the first attempt is always made to establish a connection with the default schema.

5.6.3.5. Connection of the Terminals via TCP/IP DNS / DHCP

To connect a Datafox EVO-Device with the Hostname it is necessary to set something in the DNS-Server. (In this example Windows-Server 2012)

Create a new Host (A)-value:

Abbreviation	Description
Name	Name of the device Contains the device designation and the serialnumber „deviceXX-serialnumber“ Example: „Evo28-1652“ „EVO43-8552“
full qualified domain name	This is the host name to be entered later.
IP-address	Here you must enter the IP of the device.
Create linked PTR-record	You must create a linked PTR-record. Just put this hook.

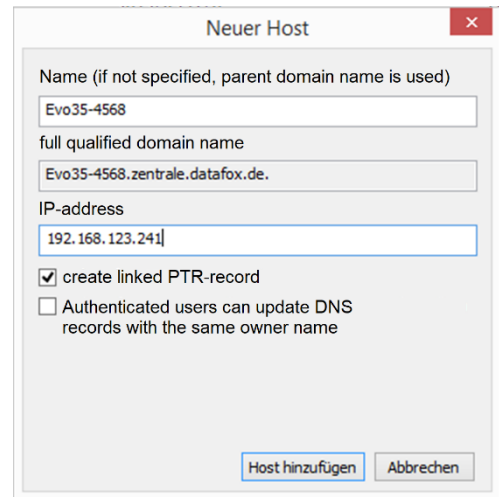

Neuer Host

Name (if not specified, parent domain name is used)
Evo35-4568

full qualified domain name
Evo35-4568.zentrale.datafox.de.

IP-address
192.168.123.241

create linked PTR-record
 Authenticated users can update DNS records with the same owner name

Host hinzufügen Abbrechen

The entry should look like this:

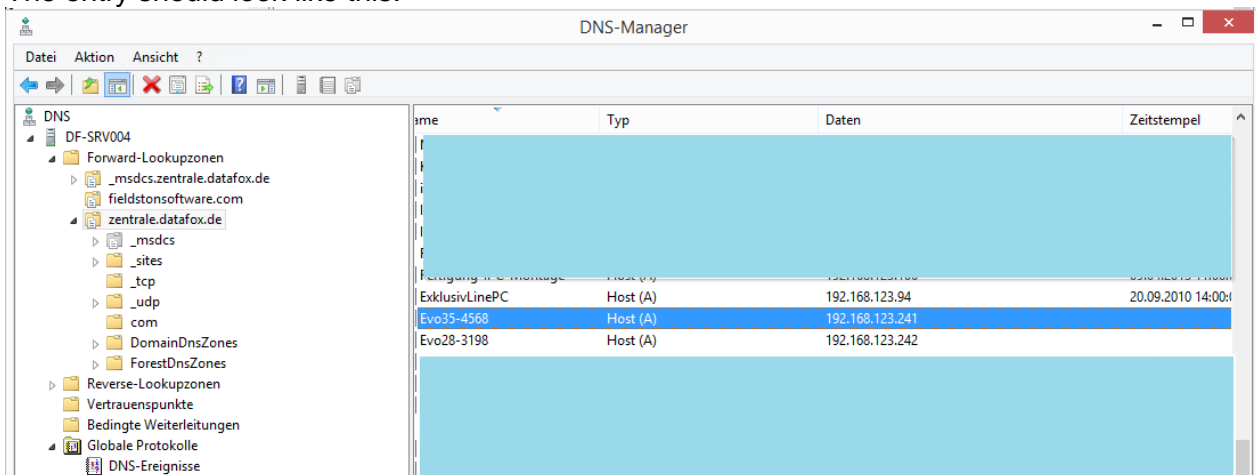

Name	Typ	Daten	Zeitstempel
ExklusivLinePC	Host (A)	192.168.123.94	20.09.2010 14:00:00
Evo35-4568	Host (A)	192.168.123.241	
Evo28-3198	Host (A)	192.168.123.242	

Settings in the DatafoxStudioIV:

Host name

Before entering, this checkbox must be set.

DHCP- entry for Datafox devices

If a device is set to DHCP, the IP address and the entry in the DHCP server can look like this.

192.168.123.109	Evo43-36100.zentrale.datafox.de	10.07.2017 23:01:31	DHCP	e4f7a100000c	Vollzugriff
192.168.123.223	Evo43-1292.Zentrale.datafox.de	Reservierung (inaktiv)	Keine	e4f7a100072f	Testgeraet Le... Vollzugriff
192.168.123.226	Support_ZK-Box V4	Reservierung (inaktiv)	Keine	e4f7a100073f	Vollzugriff
192.168.123.112	PZE-17358.zentrale.datafox.de	10.07.2017 23:51:21	DHCP	e4f7a1001964	Vollzugriff
192.168.123.125	Evo28-3705.zentrale.datafox.de	10.07.2017 14:05:02	DHCP	e4f7a100370d	Vollzugriff
192.168.123.72	Evo43-5002.zentrale.datafox.de	10.07.2017 22:58:05	DHCP	e4f7a1005070	Vollzugriff

The entry contains the following:

device	serial number	domain	DHCP- entry
EVO 2.5	10245	.zentrale.de	Evo25-10245.zentrale.de
EVO 3.5	10246	.zentrale.de	Evo35-10246.zentrale.de
AE-Master	10247	.zentrale.de	AE-10247.zentrale.de
PZE-Master	10248	.zentrale.de	PZE-10248.zentrale.de
EVO 4.3	10249	.zentrale.de	Evo43-10249.zentrale.de

5.7. Connection and wiring of the access control

5.7.1. Configuration and structure of the Access control

The basis of the access control II are tables. They store all information about the hardware configuration of the access control system, access right of the employees, periods of time (activation, blocking times, holidays,...). The tables are connected as follows:

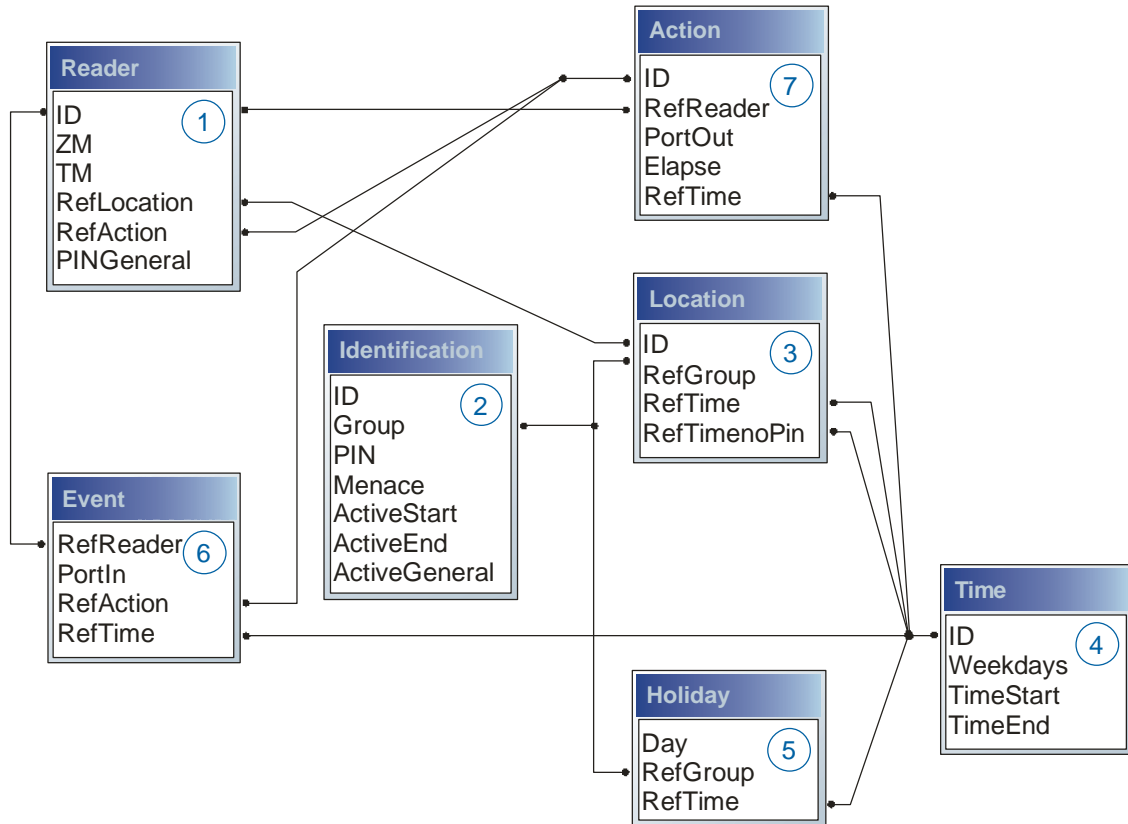

The tables are created as text files. For an easier administration you can add comments within the files.

When adding comments, you have to notice that in a comment line no field values can be given and that the comment line has to start with a semicolon.

The table Reader.txt might look like this:

ID	ZM	TM	RefLocation	RefAction	PinGeneral
1	1	320	0	1	0
2	1	000	1	2	0
3	1	010	2	3	0

Holiday Control

It is now possible for ZK-II to consider holidays at switching the relay. In order to achieve compatibility with older versions, the function consider Holidays for the Time Control of Relays has to be activated at the setup page Access Control 2. In the column Group, you specify the **Action ID** of the switched relay output instead of a Group ID. Thus, it is not necessary to alter the table structure of the holiday list. The column RefTime provides the time model applicable that day. A minus sign must be inserted in front of the Action ID in order that the MasterIV terminal can differentiate between Action ID and Group ID. As a result, these Action IDs must be three-digit numbers.

Example:

Action

ID	RefReader	PortOut	Elapse	RefTime
1	10	1	25	0
2	11	1	25	0
3	12	1	0	0

Holiday

Day	RefGroup „Action-ID“	RefTime
2012-05-01	1	3
2012-05-01	2	4
2012-05-01	-3	5

In the action list above, the door module with the ID 12 was assigned the time model 2 which switches port 1 of the module. If separate holiday control has been activated in the setup, time model 2 is not applied to the relay output at May 1, 2012, but time model 5.

Extended Parameterization ZK-II

The value range of the parameter 'ActiveGeneral' has been extended by the value 8. Additionally to the general permission (value 9), a PIN request is executed - if defined so for the user and activated for the reader. Furthermore, at both configurations of the ID cards with the ActiveGeneral value 8 and 9, the validity period of the ID card is checked.

For ZK-II the operation modes online, offline or online/offline after time-out are available. In online mode, configuration lists stored in the device are not considered. A data record is read from the server, analyzed and an action triggered. In offline mode, the configuration lists of the terminal are used to grant or deny access to a person. Online / offline after time-out is a combination. If the server is unavailable, the terminal can decide on basis of its lists whether to grant access to a person or not.

Timing of the Digital Outputs for the MasterIV Device Series:

It is possible to time the digital outputs of the MasterIV device series via tables. Thus, for example turning down the heating system at night, a buzzer control and much more can be realized.

The following tables must be configured:

- ▶ Action
- ▶ Reader
- ▶ Time

Description:

Each action that is to be activated must be entered in the table Action. The table Action refers to the tables Reader and Time. In the table Reader the module is provided on which the relay or the Open Collector is to be switched. The reference to the table Time indicates when the switch is to be done. If start and stop time are entered, the relay is switched on when exceeding the start time and switched off when exceeding the stop time. The entry of the duration Elapse in the table Action is ignored. If the relay is only to be activated for a few seconds, e.g. for a buzzer control, the stop time has to be set on "00 : 00". If the start time is exceeded, the respective output will be switched for X seconds (RefTime in Action table). The entry Elapse in the table Action now indicates the on-time.

Example:

- ▶ A buzzer is to be activated for **3** seconds from Monday to Friday at **10.00** am and 4 pm (**16.00**). The buzzer is controlled by the internal relay of the PZE-MasterIV.
- ▶ The heating system is to be set to the "day mode" at **07.00** am and to the "night mode" at 7 pm (**19.00**) on all weekdays. The corresponding relay is at the door module with the bus number **2**.

Reader.txt

ID	ZM	TM	RefLocation	RefAction	PinGeneral
1	1	320	0	0	0
2	1	020	0	0	0

Time.txt

ID	Weekdays	TimeEnd	TimeEnd
3	12345	10:00	00:00
4	12345	16:00	00:00
5	1234567	07:00	19:00

Action.txt

ID	RefReader	PortOut	Elapse	RefTime
6	1	1	15	3
7	1	1	15	4
8	2	1	0	5

5.7.2. Description of Tables for Access Control 2

Table **Reader** (List of all devices installed in the system)

Name	Data type	Length	Description
ID	Number (int)	4	Unique Key (value>0) of the Reader table.
ZM	Number (int)	4	In our example, it has number 1. If there are several PZE-MasterIVs in an access system, they can be depicted in one table connection and it is not necessary to have a separate string for each PZE-MasterIV. If several RS485 bus lines are used on a device, each additional line must be entered with Master ID + 1.
TM	Number (int)	3	Contains two information in one number. Both figures on the left (010) indicate the bus number of the door module, the figure on the right (010) contains information about the type of connection. A 0 means a connection via RS485, a 1 stands for a connection via RS232 or RS485 as stub.
RefLocation	Number (int)	4	Indicates which room is supervised by the reader.
RefAction	Number (int)	4	Indicates which action is worked through after a successful check.
PinGeneral	Number (int)	8	Can contain a numerical sequence by which a person without a card gets access.

Table **Identification** (list of all devices installed in the system - master and door modules)

Name	Data type	Length	Description
ID	Text (ASCII)	20	Contains the ID card no. which is read at the TMR33 device or terminal. An ID card can occur several times (is assigned to several authority groups).
Group	Number (int)	4	Assigns the ID card to an authority group.
Pin	Number (int)	8	Activates a PIN request if not equal 0. Please note that a PIN must not start with zero. 0815 would be invalid.
Menace	Number (int)	4	Activates (if not equal 0) a "menace-PIN" that can be added to the PIN. If entered, the system sends a data record that can be analyzed by software developed for this purpose and sets off the alarm.
ActiveStart	Text (Date)	10	The tag entered here indicates the start date of the validity of the ID card. (for example 2007-07-12 = yyyy-mm-dd)
ActiveEnd	Text (Date)	10	The tag entered here indicates the end date of the validity of the ID card. (for example 2007-07-12 = yyyy-mm-dd)
ActiveGeneral	Number (int)	1	Activates or deactivates this card record. 0 = card blocked 1 = card active 2= virtual card (use only via DLL) 3 = access only by entering the PIN; field ID are now only a PIN for access. 4 = pin = threat code i.e. the threat code is used instead of the Pin entered. 5 = The value for Duress / threat code is not transferred to the PIN adds up to form the threat code (ex: Pin = 1234, Duress = 1 -> threat code = 1235; Pin = 1234, Duress = 6 -> threat code = 1230) 6 = permanent opening for U & Z cylinders 7 = Burglary alarm system, allowed to switch on/off 8 = general authority (with PIN request) 9 = general authority (no PIN request)

Table **Location** (defines which card groups get access to which room at which time)

Identifier	Data type	Length	Description
ID	Number (int)	4	ID of the room. All other tables refer to this data line via this number, if necessary.
RefGroup	Number (int)	4	Reference to the identification table. Labels the access authorized group. All cards of this group have access to this room.
RefTime	Number (int)	4	The time model in which authorized persons get access. (0 = not used)
RefTimeNoPin	Number (int)	4	The time model for which entering an additional PIN is not necessary (at peak times etc.).

Table **Time** (grouping of single time zones (weekday from to) as a time model number)

Name	Data type	Length	Description
ID	Number (int)	4	ID of the time model. All other tables refer to this data line via this number, if necessary.
Weekdays	Number (int)	7	Indicates the weekdays on which the following period of time should be applied (form: 7 digits at most 1-7 e.g. 134567 = Monday, Wednesday till Sunday)
TimeStart	Text (Time)	5	The start point for the period of time. (form: 24h HH:MM)
TimeEnd	Text (Time)	5	The end point for the period of time.

Table **Holiday** (setting blocking days like holidays or company holidays)

Name	Data type	Length	Description
Day	Text (Date)	10	Date of the blocking day. (form: YYYY-MM-DD)
RefGroup	Number (int)	4	Indicates the authorization group to which the blocking day is applied. Zero defines a global validity for all groups.
RefTime	Text (Time)	4	Indicates the assigned time model. (0 = not used) During this time access is granted. Thus, also "half holidays" like New Year's Eve can be realized.

Table **Event** (assigning an action to a signal at the digital input)

Name	Data type	Length	Description
RefReader	Number (int)	4	Module (door module or master) where the digital input is.
PortIn	Number (int)	1	Number of the digital input on the module.
RefAction	Number (int)	4	Reference to the action that should be carried out (e.g. switch relay).
RefTime	Number (int)	4	The time model which indicates when the digital input is checked. (0 = not used).

Table **Action** (list of all workable actions in the access control system; an action group, i.e. all actions with the same action number, can switch several relays)

Name	Data type	Length	Description
ID	Number (int)	4	Action number, it can occur several times due to several actions that have to be worked through.
RefReader	Number (int)	4	Module (door module or master) on which an output(relay) is switched.
PortOut	Number (int)	1	Indicates the number of the output on the module.
Elapse	Number (int)	3	The duration of the switching of the relay (0 = permanently). Unit 200 ms
RefTime	Number (int)	4	The time model indicates when the output may be switched. (0 = not used) This is a function to switch relays directly via time (table) Please not mix this function with the normal access actions. !!! By a time-table setting "1234567 00:00-23:59" is the relay permanent on.

5.7.3. Status messages of the access control

Display /online	Pre-checked mode for online/offline access	Assigned status message
0		module detected everything OK
3		module not in the list defined but found in the bus rs485
4		module in the list reader added but not found in the bus rs485
5		wrong Encryption password
6		login password is wrong
7		RFID-typ (Mifare, Legic, Unique, etc.) wrong
8		Failed to configure the module
9		No modules
10		the Key for communication with PHG-Modules was chonged
11		the Key for communication with PHG-Modules was not chonged
12		battery-level of the doorlock phase 0 (full)
13		battery-level of the doorlock phase1
14		battery-level of the doorlock phase 2
15		battery-level of the doorlock phase 3 (empty)
16		Doorlock in mode to change battery
17		Modul Update readdy, imporent applies to EVO Agera and Interra 2)
18		Reboot after update
20	520	ID ok, accses succesful
21	521	ID is not in the list identification.
22	522	ActiveGeneral not correct.
23	523	Validity period does not fit.
24	524	Could not find the room. (group definitions)
25	525	Could not find am Time in time-table.
26	526	wait for PIN-input.
27	527	Pin wrong
28	528	threat code was input.
29	529	the PIN is right, accses successful.
30	530	the Master-PIN was input, accses successful.
31	531	PIN-Timeout.
32	532	Master-ID right, accses successful.
33	533	accses successful with PIN input.
34		Online-TP.
35		Online-PIN.
36	536	Make Action closing
37	537	Free access on this reader
38	538	Permanent blocked access
39		Online-result from the server, no access allowed

Digital	output
40	digital output 1 is low (off)
41	digital output 1 is HIGH.(on)
42	digital output 1 is for the time ELAPSE, HIGH.
43	digital output 2 is low (off)
44	digital output 2 is HIGH.(on)
45	digital output 2 is for the time ELAPSE, HIGH.
46	digital output 3 is low (Off).
47	digital output 3 is HIGH.(On).
48	digital output 3 is for the time ELAPSE, HIGH.
49	digital output 4 is low (Off).
50	digital output 4 is HIGH.(On).
51	digital output 4 is for the time ELAPSE, HIGH.
52 #	digital output 5 is low (Off).
53 #	digital output 5 is HIGH.(On).
54 #	digital output 5 is for the time ELAPSE, HIGH.
55 #	digital output 6 is low (Off).
56 #	digital output 6 is HIGH.(On).
57 #	digital output 6 is for the time ELAPSE, HIGH.

Status messages of the access control

display	Assigned status message digital output
120#	digital output 7 is low (Off).
121#	digital output 7 is HIGH.(On).
122#	digital output 7 is for the time ELAPSE, HIGH.
123#	digital output 8 is low (Off).
124#	digital output 8 is HIGH.(On).
125#	digital output 8 is for the time ELAPSE, HIGH.
126#	digital output 9 is low (Off).
127#	digital output 9 is HIGH.(On).
128#	digital output 9 is for the time ELAPSE, HIGH.
129#	digital output 10 is low (Off).
130#	digital output 10 is HIGH.(On).
131#	digital output 10 is for the time ELAPSE, HIGH.
132#	digital output 11 is low (Off).
133#	digital output 11 is HIGH.(On).
134#	digital output 11 is for the time ELAPSE, HIGH.
135#	digital output 12 is low (Off).
136#	digital output 12 is HIGH.(On).
137#	digital output 12 is for the time ELAPSE, HIGH.
138#	digital output 13 is low (Off).
139#	digital output 13 is HIGH.(On).
140#	digital output 13 is for the time ELAPSE, HIGH.
141#	digital output 14 is low (Off).
142#	digital output 14 is HIGH.(On).
143#	digital output 14 is for the time ELAPSE, HIGH.
144#	digital output 15 is low (Off).
145#	digital output 15 is HIGH.(On).
146#	digital output 15 is for the time ELAPSE, HIGH.
147#	digital output 16 is low (Off).
148#	digital output 16 is HIGH.(On).
149#	digital output 16 is for the time ELAPSE, HIGH.
300#	digital output 17 is low (Off).
301#	digital output 17 is HIGH.(On).
302#	digital output 17 is for the time ELAPSE, HIGH..
303#	digital output 18 is low (Off).
304#	digital output 18 is HIGH.(On).
305#	digital output 18 is for the time ELAPSE, HIGH..
306#	digital output 19 is low (Off).
307#	digital output 19 is HIGH.(On).
308#	digital output 19 is for the time ELAPSE, HIGH..
309#	digital output 20 is low (Off).
310#	digital output 20 is HIGH.(On).
311#	digital output 20 is for the time ELAPSE, HIGH..
312#	digital output 21 is low (Off).
313#	digital output 21 is HIGH.(On).
314#	digital output 21 is for the time ELAPSE, HIGH..
315#	digital output 22 is low (Off).
316#	digital output 22 is HIGH.(On).
317#	digital output 22 is for the time ELAPSE, HIGH..

digital	input
160#	digital input 7 is Low
161#	digital input 7 is HIGH
162#	digital input 8 is Low
163#	digital input 8 is HIGH
164#	digital input 9 is Low
165#	digital input 9 is HIGH
166#	digital input 10 is Low
167#	digital input 10 is HIGH
168#	digital input 11 is Low
169#	digital input 11 is HIGH
170#	digital input 12 is Low
171#	digital input 12 is HIGH
_____	_____continuously until:
210#	digital input 32 is Low
211#	digital input 32 is HIGH

for new devices hardware version 4

BSD/ EMA	Discription/ Beschreibung
258 ¹	The access control system awaits legitimation through RFID transponder and/or PIN after starting a BDS control event due to entering the operating code.
259	The access control system awaits legitimation through RFID transponder and/or PIN after starting a BDS control event due to entering the operating code.
260	During a BDS control event a non-privileged RFID transponder has been presented to the reader. This transponder is either not contained within the Identification table or does not have ActiveGeneral set to 7. See Privileging transponders to control the BDS.
261	The specified BDS section is not configured correctly.
262	There are no concurrent BDS control events supported while a BDS control event is currently being processed.
263 ¹	The BDS signals that is ready to be armed.
264 ¹	The BDS signals that is not ready to be armed.
265	The relay to arm the BDS section has been set.
266	The relay to disarm the BDS section has been set.
267	The BDS section to be armed is already armed. The reader signals "green" anyway so that the operator knows that the BDS section is armed.
268	The BDS section to be disarmed is already disarmed. The reader signals "green" anyway so that the operator knows that the BDS section is disarmed.
269 ¹	The BDS section is armed now.
270 ¹	The BDS section is disarmed now.
271	The BDS section could not be armed within five seconds. The digital input pin associated to the BDS section state still reports the section as disarmed.
272	The BDS section could not be disarmed within five seconds. The digital input pin associated to the BDS section state still reports the section as armed.
273	The access request was denied due to the BDS section being armed.
274	Identification requires an additional PIN.
275	The PIN entered does not match the stored one.
276	The PIN entered matches the stored one.
277	Timeout while waiting for the PIN to be entered.

1) This status code contains the BDS section [1..5] as property „ID number“.

Status messages of the access control

display	Assigned status message		
100	the access-control is off.		
101	server not online (online accses-control)		
102	the device have no lists.		
103	Type not correct in setup settings (GIS, PHG).		
display	Assigned status message		
	Master (ZK-Box / ZK Master)	GIS / TS-Series reader	PHG / EVO-ZK-reader
60	Digital input 1 Master Low	Digital input 1 Reader Low	Digital input 1 (IO-Box is closed)
61	Digital input 1 Master High	Digital input 1 Reader High	Digital input 1 (IO-Box is open)
62	Digital input 2 Master Low	Digital input 2 Reader Low	Digital input 2 (IO-Box closed)
63	Digital input 2 Master High	Digital input 2 Reader High	Digital input 2 (IO-Box open)
64	Digital input 3 Master Low	Digital input 3 Reader Low	Digital input 3 low
65	Digital input 3 Master High	Digital input3 Reader High	Digital input 3 high
66	Digital input 4 Master Low	Digital input 3 wurde unterbrochen	PHG not used
67	Digital input 4 Master High	Digital input 3 wurde kurz geschlossen	PHG not used
68	Digital input 5 Master Low	not used	not used
69	Digital input 5 Master High	not used	not used
70	Digital input 6 Master Low	not used	digital input 1 the Reader Low nicht bei der Voxio-E-Serie
71	Digital input 6 Master High	not used	didigital input 1 on the Reader High nicht bei der Voxio-E-Serie
72		not used	digital input 2 on the Reader Low nicht bei der Voxio-E-Serie
73		not used	digital input 2 am Reader High nicht bei der Voxio-E-Serie
74		not used	tamper switch → OK
75		not used	tamper switch → device manipuliert
display	Assigned status message		
80	alarm-input 1		
81	alarm-input 2		
82	alarm-input 3		
83	alarm-input 4		
84	alarm-input 1		
85	alarm-input 6		
220#	alarm-input 7		
221#	alarm-input 8		
_____	_____ continuously until:		
245#	alarm-input 32		

for new devices hardware version 4

Status message of the access control in a record:

Note:

Do you want see the status from access control, to choose this settings in the Setup.



field name, in accordance	State	▼
Field function :	Access: State assume	▼

5.7.4. Wiring of the access-control reader

5.7.4.1. Connecting of one access-control reader

Wiring for one Door, one relay, Oneloc on tcp/ip:

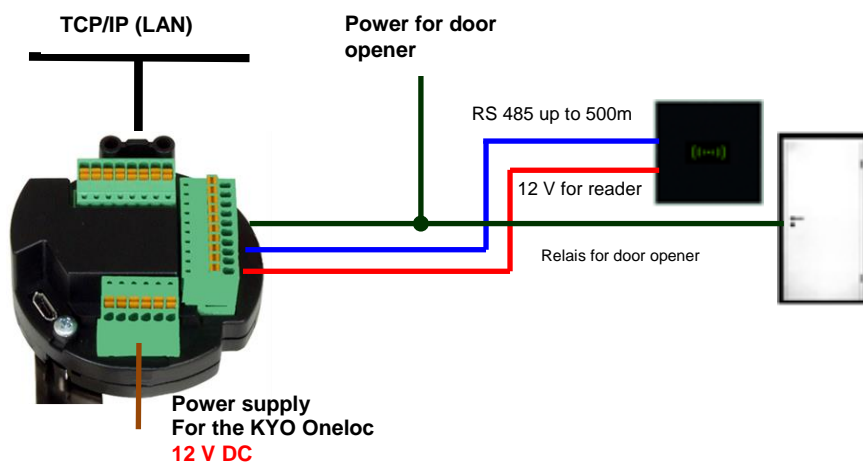

Wiring for one Door, one relay with EVO Intra 2:

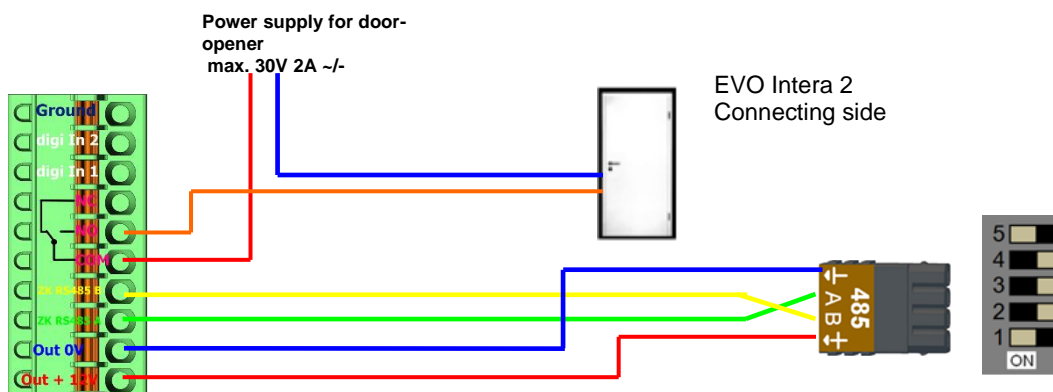

Wiring for one Door, one relay with EVO Intera:

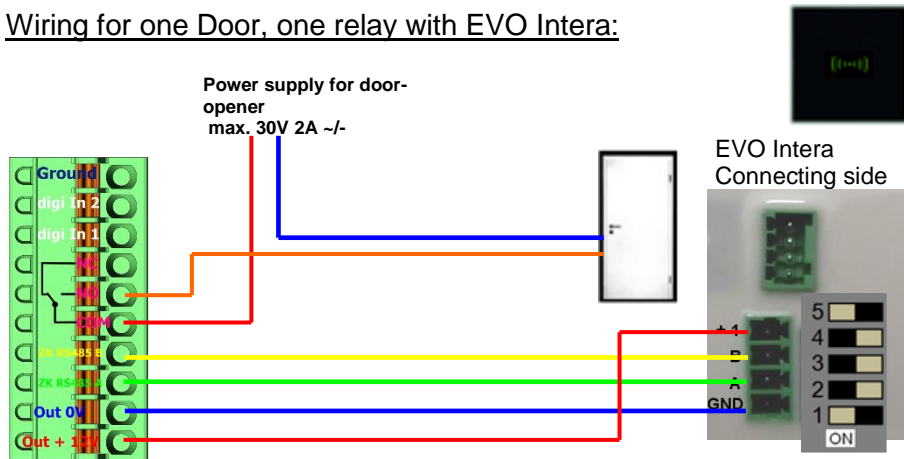

Wiring for one Door, one relay with EVO Agera:

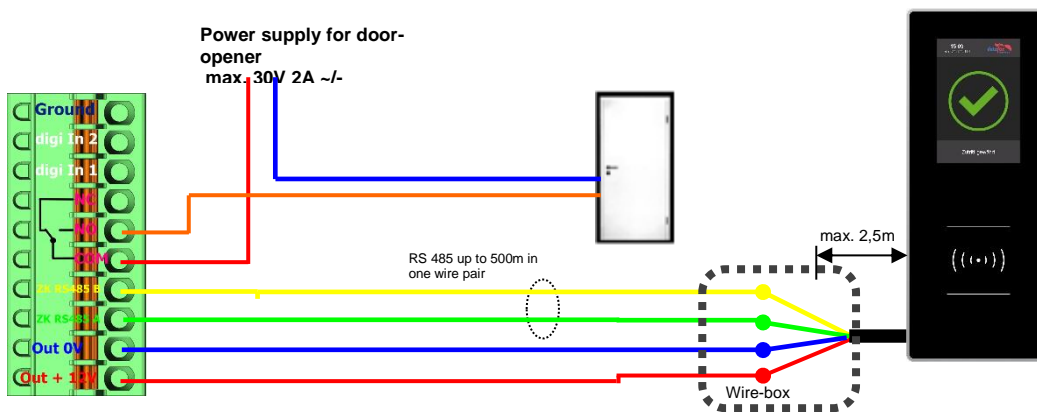

Wiring for one Door, one relay with PHG-reader:

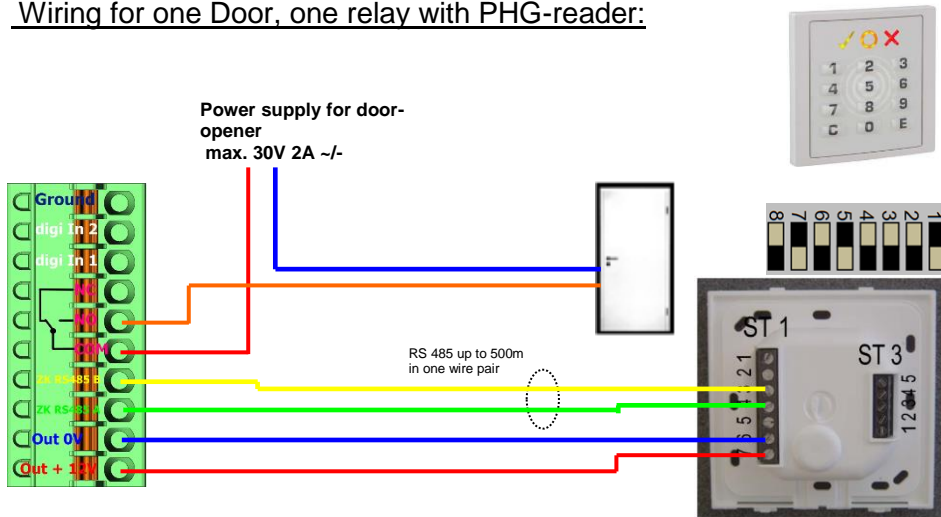

Wiring for one Door, one relay with Siedle-reader:

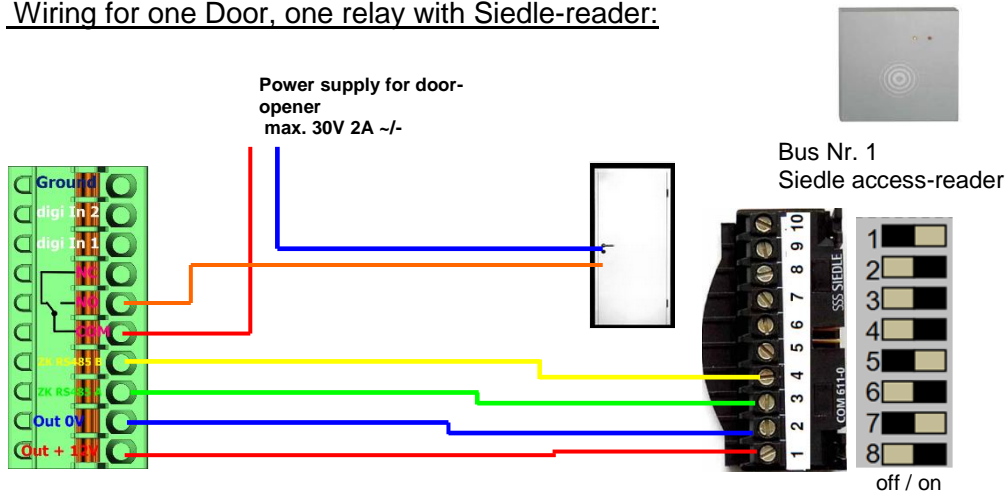

Wiring for one Door, one relay with PHG Relino-Reader:

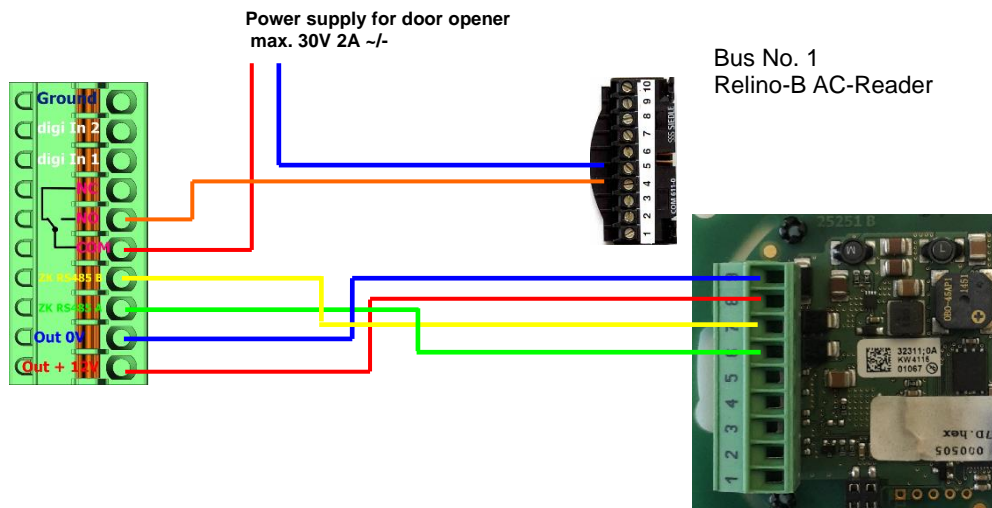

Wiring for one Door, one relay with PHG VOXIO-T-Z-Reader:

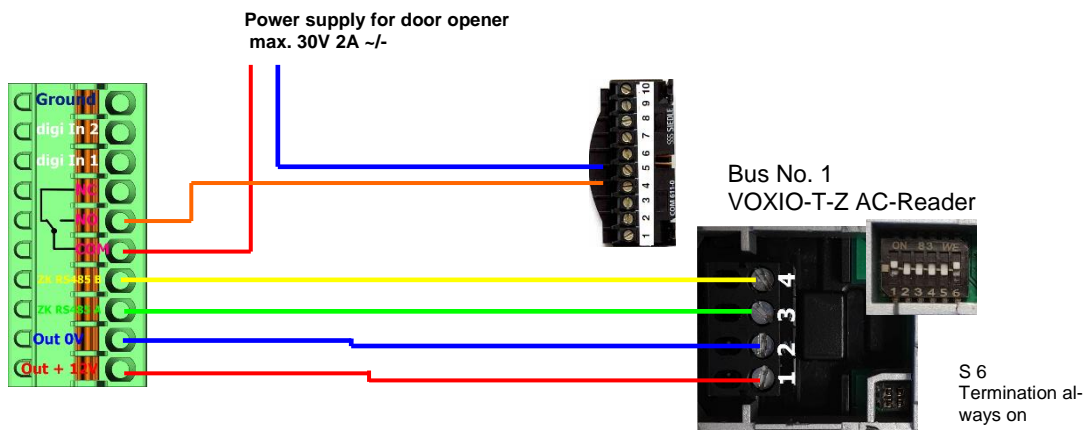

5.7.5. Instructions for the electrician for installing the access control system

5.7.5.1. Star-shaped bus wiring

**! Incorrect star connection of the RS485 bus.
RS485 wire pairs must not be connected in parallel.**

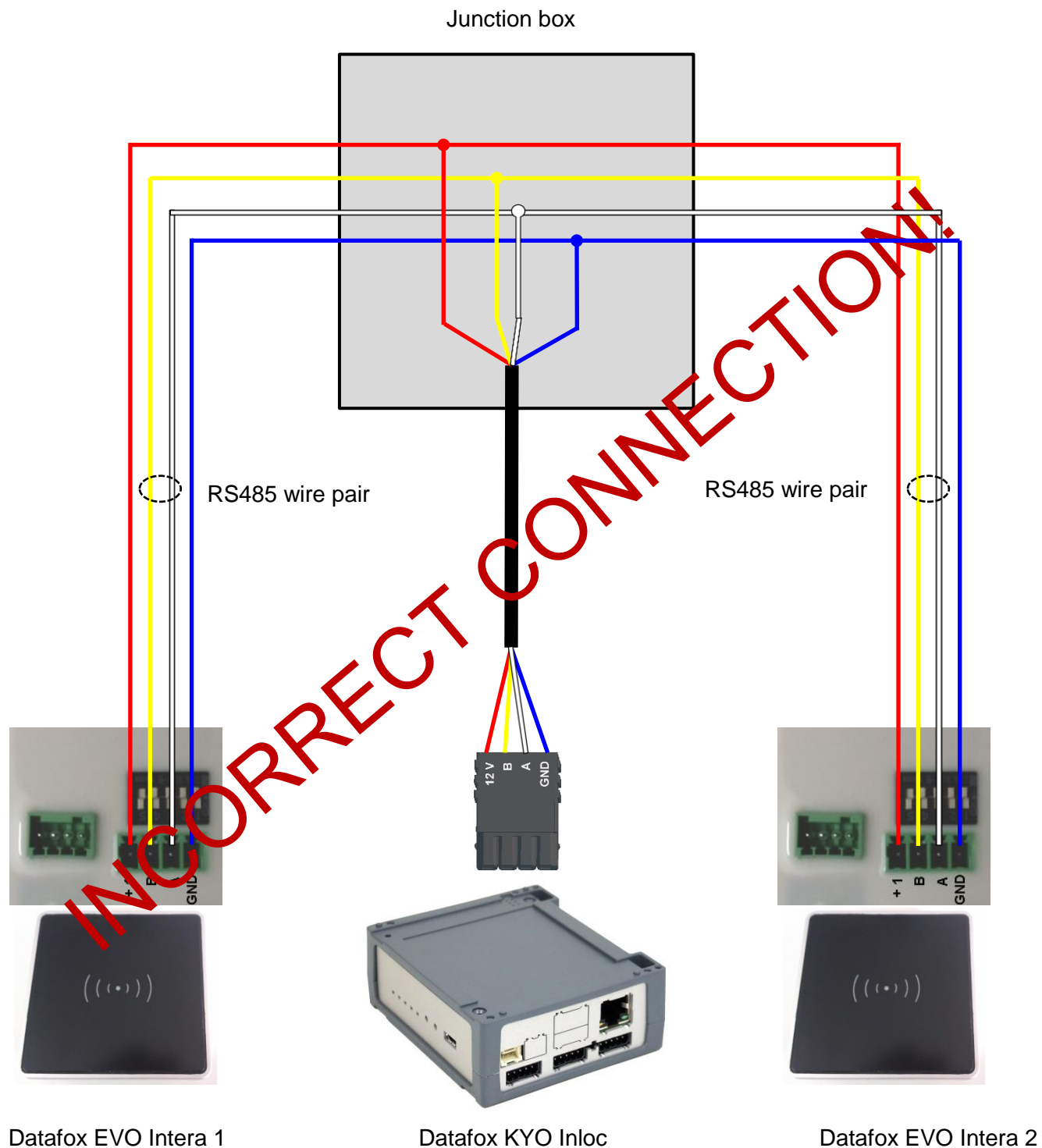

Correct!

Correct bus wiring of the access readers with star-shaped cable routing.

The wiring must not be parallel from one point. The wire pairs A and B must each be routed in series directly to the terminal of a reader and from there on to the next bus device in order to ensure smooth operation of the bus communication.

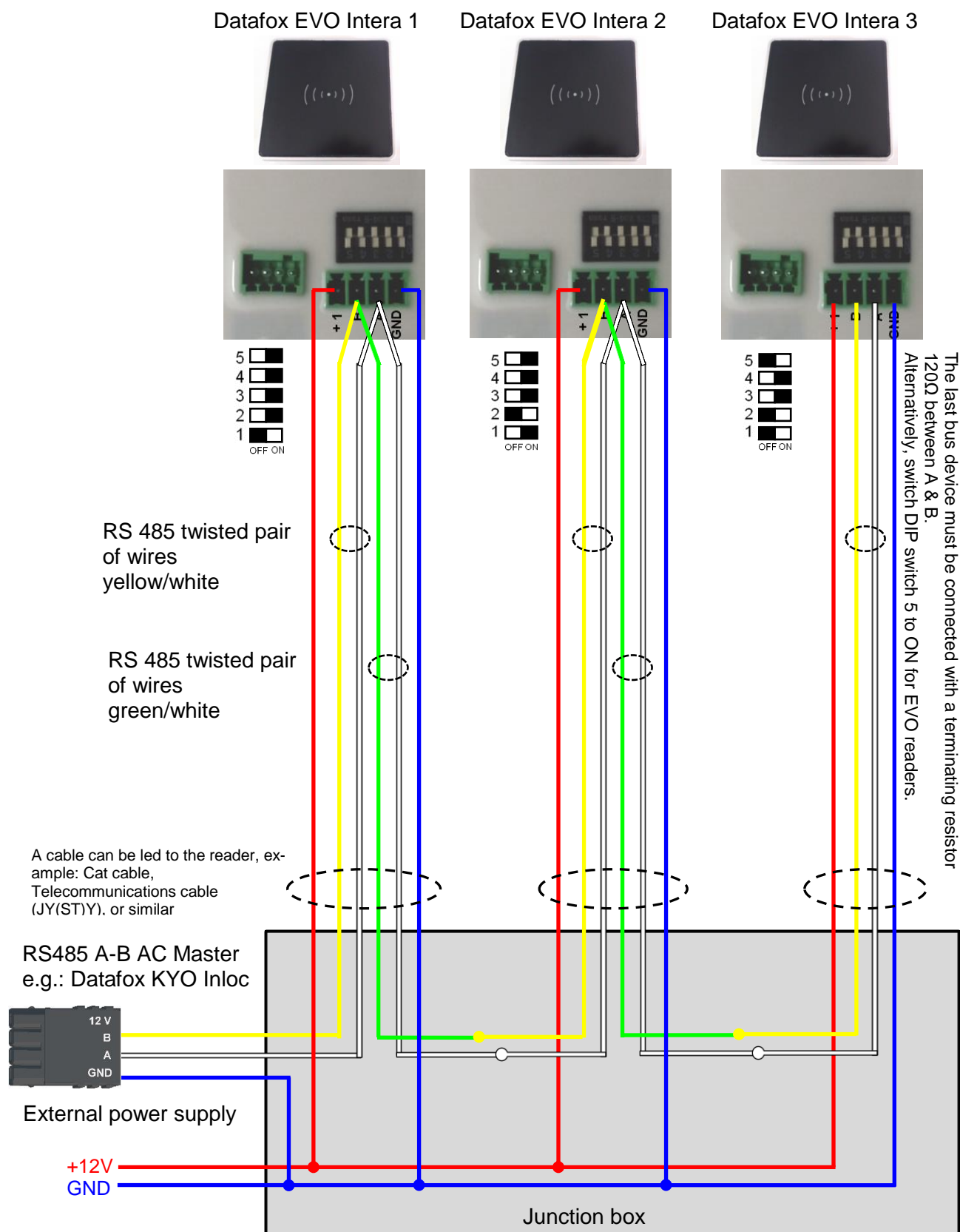

5.7.6. Calculation for the power supply of Access modules

When using Datafox access readers or door modules, the necessary cable cross-section has to be calculated before setting up an RS485 network for access control. The voltage drop in the whole bus must not exceed 4 V. Please note that if you use a Datafox device power supply unit as voltage source, 16 modules at most (8 in the RS485 bus and 8 via RS232 stub line) can be fed.

Maximum power consumption of the single modules:

TS-TMR33-TR	56,5 mA	16 V max. 8 V min.DC
TS-TMR33-TM	156,0 mA	16 V max. 8 V min.DC
TS-TMR33-TMR	180,0 mA	16 V max. 8 V min.DC
EVO-reader	250,0 mA	24 V max. 9 V min.DC
PHG-reader	250,0 mA	24 V max. 9 V min.DC

The result is a permissible maximum power consumption per Datafox power supply unit of (8 x 180.0 mA + 8 x 56.5 mA) 1.9 A. In order to assure this, you can calculate the necessary cross-section for a given cable length or the permissible maximum cable length for a given cable cross-section.



Caution:

Before setting up and commissioning a ZK-network, the calculation has to be done by a person qualified in this field.

The cable cross-section is calculated as follows:

$$Q = \frac{2 \cdot I \cdot l}{k \cdot U_v}$$

Q = wire size in mm²

I = current

l = wire length in m

k = Conductivity for copper $56 \frac{m}{\Omega \cdot mm^2}$

The following applies for 12 V voltage supply:

U_v = voltage drop. 4V at most. **4 V TMR33**

U_v = voltage drop. 4V at most. **3 V PHG** and Reder **EVO-ZK**

U_v is calculated from the supply voltage minus the minimum voltage for the reader.

Thus, the equation for calculating the maximum cable length for a given cable cross-section is:

$$l = \frac{Q \cdot k \cdot U_v}{2 \cdot I}$$

5.7.7. Cable length and cable cross section for access wiring

Wiring:

Cables with a core diameter of 0.6 or 0.8 mm can be used as bus cables.

The following types of lines are suitable, e.g. as bus line:

- J-Y(ST)Y (telecommunication cable),
- YR (jacketed cable),
- A-2Y(L)2Y (telecommunication cable)

Cat 7 Cable for Network structure!

The maximum total line length BUS RS485 A and B wire is 1000 m. Here are one pair for the A and B data line in use.

Cable lengths for the voltage supply of the readers.

power supply 1 reader from the box to the power supply 12V:

- 0,6 mm Cable cross section: 200 m,
- 0,8 mm Cable cross section: 350 m.

power supply 1 reader with separated power supply 12V:

- 0,6 mm Cable cross section: 250 m,
- 0,8 mm Cable cross section: 400 m.

power supply 2 reader with separated power supply 12V:

- 0,6 mm Cable cross section: 125 m,
- 0,8 mm Cable cross section: 200 m.

power supply 3 reader with separated power supply 12V:

- 0,6 mm Cable cross section: 65 m,
- 0,8 mm Cable cross section: 130 m.

power supply 1 reader with separated power supply 24V:

- 0,6 mm Cable cross section: 500 m,
- 0,8 mm Cable cross section: 800 m.

5.7.8. Online functions for the access control

The access control mechanism offers the functionality to control every configuration and action in your software-solution.

So you can

This allows you to react to all requests from the access control in real time.

Activate the online function in the setup under the basic settings tab.

There are 2 options:

- Offline Mode (the device always waits for the answer from the server)
- In the option **Online/Offline** the terminal waits a defined time before switching to the offline functionality. If this happens the terminal will use the access lists in its memory.

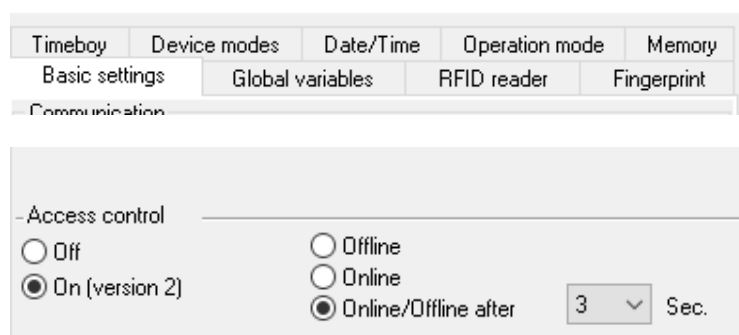

5.7.8.1. Online via http-protocol

The communication with http is very quick and easy to set up. Therefore the webserver has an easy job to react to the requests in a very short period of time.

Requirements:

Hardware:

- TCP/IP
- GPRS (1-2 seconds delay)

Software:

- Active Script with a logic for the access control and specially designed to suit the connected hardware (access reader)

With the answer from the server you are able to perform specific actions with the access readers.

The following examples will give you an insight in what is possible with the functions and actions. All parameters correspond the online functions with the dll.

Example 1:

The following data is going to be received

`table=access&date_time=2013-07-05_07%3A48%3A11&Master_ID=1&Modul_ID=010&Chip_Nr=2058&Status=34&checksum=2461`

<code>Master_ID=1</code>	Master-ID
<code>Modul_ID=010</code>	bus adress of the reader / TM
<code>Ausweis_Nr=2058</code>	ID of the read Chip
<code>Status=34</code>	Online (34)

Fitting answer to grant access:

`status=ok&checksum=2461&access=010&mask=8&type=1&duration=1`

With firmware-version 04.03.04 and up also possible is:

`status=ok&checksum=2461&master=1&module=010&mask=8&type=1&duration=1`

<code>access=010</code>	bus adress, on which the action will take place (FW 04.03.03 and lower)
<code>module=010</code>	bus adress on which the action action will take place
<code>master=1</code>	rs485-bus on which the action action will take place
<code>mask=8</code>	relais Nr.1
<code>type=1</code>	turn-on
<code>duration=1</code>	for 1 second

Fitting anser to deny the access => Red-LED:

`status=ok&checksum=2482&access=010&mask=5&type=1&duration=2`

ab der Firmware 04.03.04 ebenfalls möglich ist:

`status=ok&checksum=2461&master=1&module=010&mask=8&type=1&duration=1`

<code>access=010</code>	bus adress, on which the action will take place (FW 04.03.03 and lower)
<code>module=010</code>	bus adress on which the action action will take place
<code>master=1</code>	rs485-bus on which the action action will take place
<code>mask=5</code>	red LED + buzzer
<code>type=1</code>	turn-on
<code>duration=2</code>	for 1 second

Several bus strings can be controlled with the new hardware V4. In order to be able to execute actions on the corresponding bus string, the bus string ID must be transferred with the response as well.

For this, the new keywords "module" and "master" were implemented. These must be used together, replacing the keyword "access".



Attention:

The order "**access→mask→typ→duration**" or **master→module→mask→typ→duration** must be strictly adhered to.

`status=ok&checksum=2482&access=010&mask=5&type=1&duration=2`
`status=ok&checksum=2482&master=1&module=010&mask=5&type=1&duration=2`

Overview of the possible parameters for the keywords:

keyword	value / Bit Nr.	description
access= or module= function for 1x Bus RS485	000 010 011 ... 081 usw.	The value of the string must follow the format of the "TM" field of the "Reader" list. He must therefore always include 3 digits.
master =	1-3 1 2	Id for the RS485 bus ZK, represents the ZK- rs485-bus. RS485 Bus ID 1 RS485 Bus ID 2... „ master “ has to be set together with „ module “ and so replaces the function „ access “
mask	1 / 0	this bit will trigger the buzzer.
	2 / 1	this bit will trigger the green LED.
	4 / 2	this bit will trigger the red LED.
	8 / 3	this bit will trigger the first relay.
	16 / 4	this bit will trigger the second relay.
	32 / 5	this bit will trigger the third relay.
	64 / 6	this bit will trigger the fourth relay.
	128 / 7	this bit will trigger the fifth relay.
	256 / 8	this bit will trigger the sixth relay.
	unused. always set to 0
type	0	Off
	1	On
	2	change (600ms on, 600ms off)
	3	3 times on for 500ms
duration	Sekunden / 0	Is a period of time and only at =1 active. meaning: 0 = always on, 1 - 40 = seconds on.



Hint:

You can also perform multiple actions on the access control in one response. However, the total length of the response must not **exceed 254 characters**.

Attention:

A automated switch between online and offline mode is not possible in http mode



- Access control

Off

On (version 2)

Offline

Online

Online/Offline after

3 Sec.

5.7.8.2. Online via DLL connection

The dll offers the function to directly access the external access reader. With the function “DFCEntrance2OnlineAction“you are able to trigger the buzzer, the LEDs and the relays.

In the case of an access booking, the access master generates a data record. This must be picked up immediately and forwarded to the application on the server. The application then decides whether access is granted and returns a command to control the relay in the door module or lets the buzzer sound and issues a visual message via the LEDs.

More dll functions are documented in the “Datafox SDK” on our website

https://www.datafox.de/downloads-datafox-kyo-inloc.de.html?file=files/Datafox_Devices/Downloads_Geraete_Zubehoer/001_MasterIV-Software/Datafox_SDK_Windows_04.03.12.zip

5.7.9. Function extension for access control II

5.7.9.1. General description

The access control has been extended to some functionality. To the table "Action 2" was introduced. This table replaces the previously known "Action". On the end of this chapter you find a description for the table „Action2“. Due to a lot of additional references many scenarios are now possible.

The entire logic of the access control lies in the links between the access lists. Here is an overview of the links between the access lists:

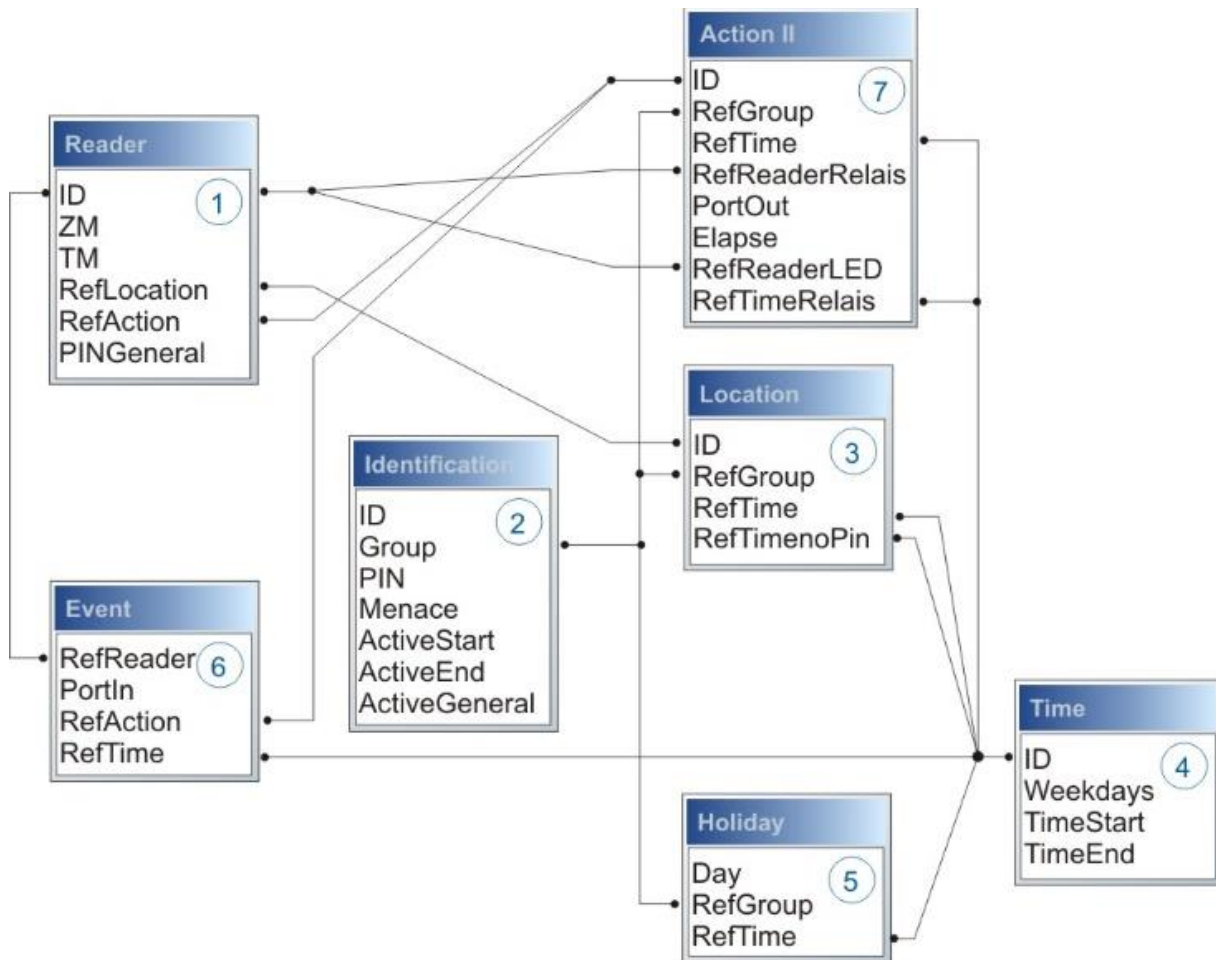

The following example gives an overview:

5.7.9.2. Examples

Example - Garage:

The facility manager comes in the morning at 7.00 o'clock and uses the Entry 1.

- with his RFID-chip he opens the door 1 for 5 seconds.
- with the same action he gives the door 3 free, the opening is now possible with a switch, until 4 o'clock pm.
- entry 2 is now open until 4 o'clock pm for the other person.

the closing is possible with:

- 1 – one RFID-chip registry on group 40
- 2 – double read of a normal RFID-chip
- 3 - Automatic at 4 o'clock pm (define in the time table, see in row 2 „RefTime“)

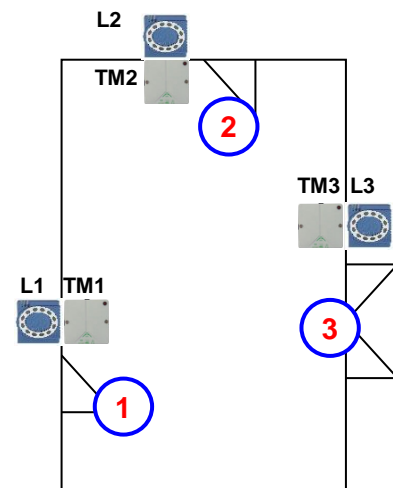

Construct of Reader-, Location-, Action2- and Identification-table looks maybe at follows

Table Reader

ID	ZM	TM	RefLocation	RefAction	PinGeneral	Description text
1	1	320	0	0	0	Master device
2	1	010	100	0	0	Door-module on RS485 wire (TM1) only relays include Need not a listing in the table „action“
3	1	011	100	1000	0	RFID-reader on RS232 wire (L1) only reader All readings of RFID on this reader make all actions in the table „action“, with the ID 1000.ID 1000.
4	1	020	200	0	0	Door-module on RS485 wire (TM2) only relays include Need not a listing in the table „action“
5	1	021	200	2000	0	RFID-reader on RS232 wire (L2) only reader All readings of RFID on this reader make all actions in the table „action“, with the ID 2000.
6	1	030	300	0	0	Door-module on RS485 wire (TM3) only relays include Need not a listing in the table „action“
7	1	031	300	3000	0	RFID-reader on RS232 wire (L3) only reader All readings of RFID on this reader make all actions in the table „action“, with the ID 3000.

Table Time

ID	Weekdays	TimeStart	TimeEnd	Description text
1	1234567	00:01	23:59	24hours opening possible
2	1234567	07:00	16:00	Time for special action

Table Action2

ID	RefGroup	RefTime	RefReader Relais	PortOut	Elapse	RefReader LED	RefTime Relais	Description
Read an RFID chip on reader 1								
1000	10	0	2	1	5	3	0	Opening normal for 5s. Group (10; 20; 30) have always entrance
1000	20	0	2	1	5	3	0	
1000	30	0	2	1	5	3	0	
1000	30	2	4	1	32400	5	0	door 2 open for 9h (max. 16:00)
1000	30	2	6	1	32400	7	0	door 2 open for 9h (max. 16:00)
1000	40	0	2	1	-1	3	0	command door open, return
1000	40	0	4	1	-1	5	0	command door open, return
Read an RFID chip on reader 2								
2000	10	0	4	1	5	5	0	Opening normal for 5s. Group (10; 20; 30) have always entrance
2000	20	0	4	1	5	5	0	
2000	30	0	4	1	5	5	0	
2000	30	2	4	1	32400	5	0	door 3 open for 9h (max. 16:00)
2000	30	2	6	1	32400	7	0	door 3 open for 9h (max. 16:00)
2000	40	0	4	1	-1	5	0	command door open, return
2000	40	0	6	1	-1	7	0	command door open, return
Read an RFID chip on reader 3								
3000	0	0	6	1	5	0	0	This action is for all Groups are listed in the table "Location".

Table Location

ID	refGroup	refTime	refTimeNoPin	Description
100	10	1	0	Group 10, 20, 30 and 40 have access on this reader.
100	20	1	0	
100	30	1	0	
100	40	1	0	
200	10	1	0	Group 20 can not use this entrance 2.
200	30	1	0	
200	40	1	0	
300	10	1	0	The Master of Garage and the facility manager can open this door.
300	30	1	0	

Table Identification

ID	Group	Pin	Menace	ActiveStart	ActiveEnd	Active	Description
1111	10	0	0	2005-01-01	2015-12-31	1	Master of Garage
2222	20	0	0	2005-01-01	2015-12-31	1	Skilled workers
3333	30	0	0	2005-01-01	2015-12-31	1	Facility manager
4444	40	0	0	2005-01-01	2015-12-31	1	Facility manager second RFID-chip, only for closing the door

Example - elevator

The goal is to allow users only to exit at the allowed floor.
Then tenant uses the transponder to activate only the switch for his floor.

In the cabin of the elevator the RFID-reader is installed. The Datafox-Device is on the top of the cabin.

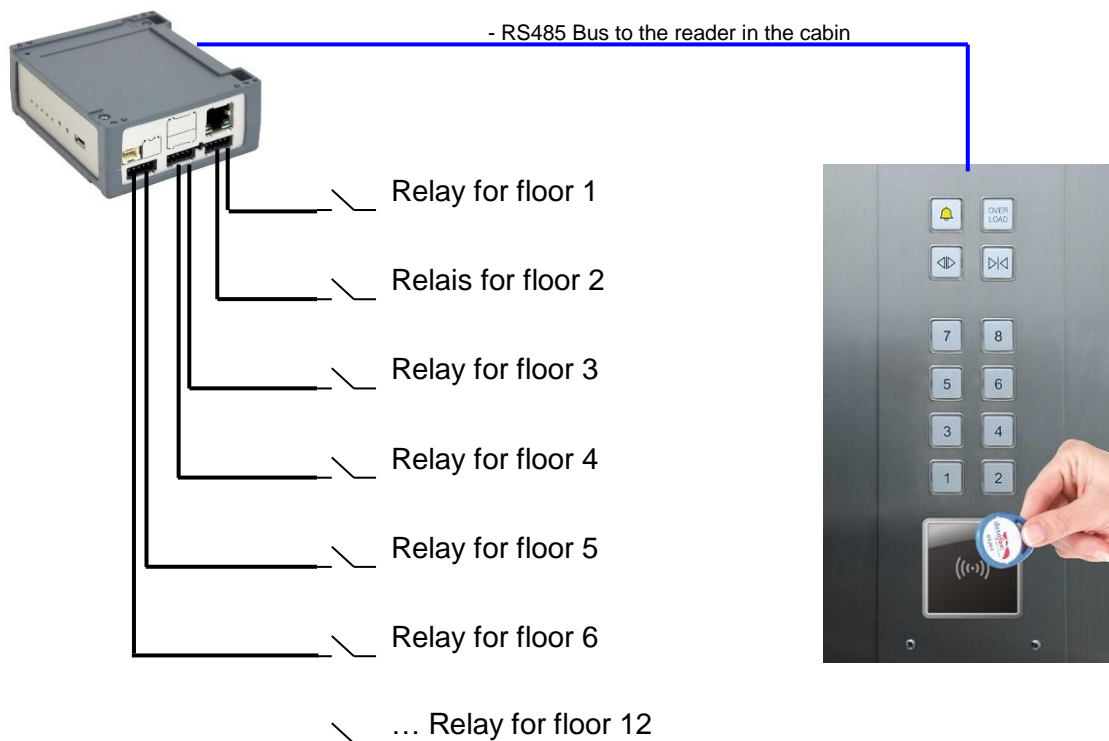

Wiring plan for the EVO-Access reader:

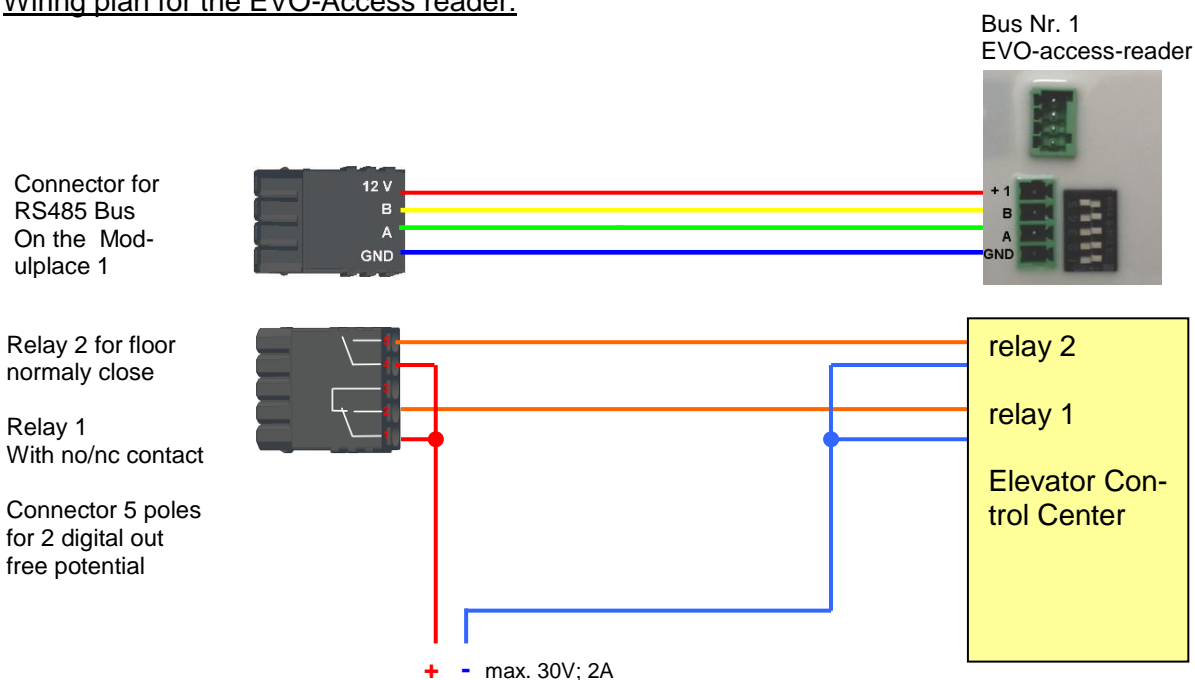

The content of Reader-, Location-, Action2- and Identification- might look like follow:

Table Reader

ID	ZM	TM	RefLocation	RefAction	PinGeneral	Description
1	1	320	0	0	0	Master device
2	1	000	100	1000	0	Reader on RS485 wire

Table Action2

ID	RefGroup	RefTime	RefReader Relais	PortOut	Elapse	RefReader LED	RefTime Relais	Description
Buchungen am Leser in der Kabine								
1000	10	0	1	1	20	2	0	Group 10 only for floor 1.
1000	20	0	1	2	20	2	0	Group 20 only for floor 2.
1000	30	0	1	3	20	2	0	Group 30 only for floor 3.
1000	40	0	1	4	20	2	0	Group 40 only for floor 4.
1000	50	0	1	5	20	2	0	Group 50 only for floor 5.
1000	60	0	1	6	20	2	0	Group 60 only for floor 6.
1000	102	0	1	1	20	2	0	Group 102 moving to floor 1 and 2
1000	102	0	1	2	20	2	0	
1000	104	0	1	1	20	2	0	Group moving to floor 1, 2 and 3.
1000	104	0	1	2	20	2	0	
1000	104	0	1	3	20	2	0	

Table Location

ID	refGroup	refTime	refTimeNoPin	Note
100	10	1	0	All Groups 10, 20, 30, 40, 50, 60,102 and 104 must listed in the location for this reader.
100	20	1	0	
100	30	1	0	
100	40	1	0	
100	50	1	0	
100	60	1	0	
100	102	1	0	
100	104	1	0	

Table Identification

ID	Group	Pin	Menace	ActiveStart	ActiveEnd	Active	Description
1111	10	0	0	2005-01-01	2099-12-31	1	Tenant of an apartment on the floor 1
2222	20	0	0	2005-01-01	2099-12-31	1	Tenant of an apartment on the floor 2
3333	30	0	0	2005-01-01	2099-12-31	1	Tenant of an apartment on the floor 3
4444	40	0	0	2005-01-01	2099-12-31	1	Tenant of an apartment on the floor 4
5555	50	0	0	2005-01-01	2099-12-31	1	Tenant of an apartment on the floor 5
6666	60	0	0	2005-01-01	2099-12-31	1	Tenant of an apartment on the floor 6
1102	102	0	0	2005-01-01	2099-12-31	1	Tenant of an apartment on the floor 1 and 2
1104	104	0	0	2005-01-01	2099-12-31	1	Tenant of an apartment on the floor 1, 2 and 3

5.7.9.3. Description of the table „Action2“

The switching from „Action“ to „Action2“ it's a setting in the StudioIV.

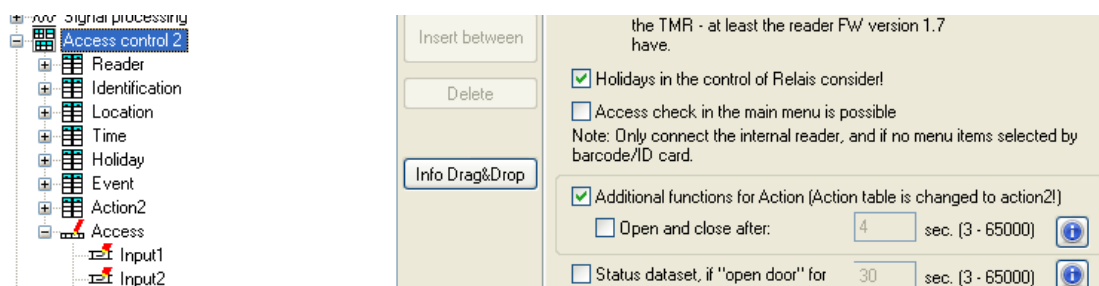

Name	Data type	Length	Description
ID	Number (int)	4	Action number, it can occur several times due to several actions that have to be worked through.
RefGroup	Number (int)	4	Only work this action for the listed Group. 0 = for all groups work this action.
RefTime	Number (int)	4	Give a time, and only works this action to this time. (0 = works ever) ! Not mixed with times in RefTimeRelais!
RefReader Relais	Number (int)	4	Reference to the list reader, action to switch a relay on this listed reader in table reader.
PortOut	Number (Byte)	1	Switch relay 1 or 2
Elapse	Number (int)	6	Specifies the period of time a relay is switched ! The time is in seconds! When (-1) is specified, the relays are reset directly. With (0) the relays switch for the duration specified for the relay with RefTime. "FRA" activates Free Access "BLA" activates Blocked Access = permanent red signal "STD" returns to Standard mode.= Deactivate from FRA or BLA
RefReaderLED	Number (int)	4	This is a reference to the table Reader to switch the LED on other modules
RefTimeRelais (nur für Automatische Zeitsteuerung)	Number (int)	4	The time model indicates when the output may be switched. (0 = not used). (Automatic time control) ! Action how here work with automatic times, be not mixed with action from the access!



Caution:

By transferring the table "Action 2" to the unit, the table "action" is replaced. Thus, only entries in the table "Action 2" will be considered.



Caution:

If you would like to continue working with the "action" table, the table "Action 2" may not be transferred to the device.
A table "Action 2" has already been transferred to the device, it must be cleared by loading a new setup.

5.7.9.4. Additional functions for Access Control

All functions described below are only supported in conjunction with the Action 2 table.

Possible functions:

- Logging, in an internal list, in which room each employee is located.
- Hard antipassback
- Soft antipassback (= only the software is informed that an ID card has entered a room 2 times = status message 251)
- BDS
- Type associated to the supervised door unctinality.

The table "ReaderProps" must be created under the table structure of the operation:

Name	Data type	Length	Description
RefReader	Number (int)	4	Reference to the ID of the Reader whose properties should be specified
Type	Number (int)	2	Type of the Property 1 = anti-passback 2 = BDS-System 3 = BDS 4 = BDS 5 = Type associated to the supervised door unctinality.
Mode	Number (int)	1	Mode for details of the type above 1 - Only protocol the attendance of persons in a room (in list "presence"). 2 - Hard anti-passback (no entry when conflict detected, status code 250) 3 - Soft anti-passback (entry allowed when conflict detected, status code 251).
Duration	Number (int)	10	Access is permitted again after the duration time has elapsed. Value in seconds. 0 = no end time. It is necessary to enter another room necessarily

The table "ReaderProps" is created in the setup:

Protocol - Function

Essentially serves to ensure that when several access managers are used, they know in which room a person is located.

Via your software, this information is distributed between the access managers or can be read out if required.

See the documentation DFComDLL

- DFCTable.....
- DFCPresence....

Soft antipassback

A status message 251 is issued here if one and the same badge enters the same room more than once. Admission is still permitted!

Hard antipassback

A reader is always assigned to a room. This room may then only be entered once with the same ID. If the same ID card is used again for access to this room, it will be rejected. Status 250 is output in the data record during access control.

Here you can choose whether the reject is limited in time or whether Hard remains active.

In the case of Hard Active, access is not permitted again until another room ID has been accessed. This corresponds to leaving the previous room.

5.7.9.5. List Presence

This list is created by the access controller itself.

This makes it possible to enable the tracking of people and rooms via several access controllers. If the Antipassback function is to be used via several access controllers, this list must always be updated by the software to all access controllers.

Example:

A room (example room ID 10) has several doors that are managed by different access control boxes. If a person enters this room, an entry is created in the Presence list of this box that this person is in the room.

The other access control boxes can now also be informed that the person with ID X is in room 10. To do this, an entry in the Presence list must be created in the other boxes via your software (with DLL).

This is done using the method [DFCTableAppendRowData](#) Append Data Row to the table.

The same applies if a person leaves the room, this entry must be deleted in the Other Access Control Boxes.

Name	Data type	Length	Description
ID	Number (int)	4	ID of the person that is stored in the presence list.
RefLocation	Number (int)	4	Reference to the ID of the room, defined in the table "Location", where this person currently stays
TimeStamp	Number (int)	10	Time stamp when the person entered the current room Integer in seconds, starting 01.01.2000.

5.8. RFID Reader

The RFID reader is built-in the EVO 3.5 Universal. If this option is available, see the type label and the label on the backside. By DatafoxStudioIV you can enable the RFID reader. For more information see the manual of DatafoxStudioIV.

For reading a transponder you must hold it in front of the device. The reading area is marked with the corresponding icon.

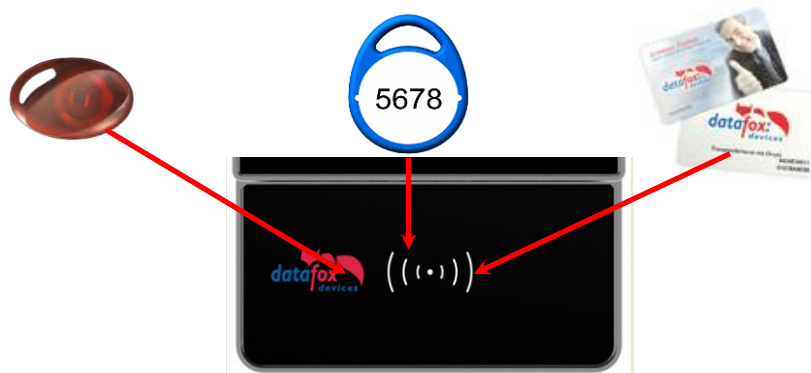

The following transponder readers can be built-in the EVO 3.5 Universal :

EVO 3.5 Universal with 125 kHz: Unique EM4102, Hitag1, Hitag2, HitagS, Hewi EM4450
LRW 8 cm R/W (**LeseReichWeite** "Read range" with card)

EVO 3.5 Universal with Legic-Prime/Advant: LRW 4 cm R/W

EVO 3.5 Universal with Mifare-Desfire: LRW 4 cm R/W für MifarePlus / 7 Byte UID necessary



Note:

More information you found in the manual from DatafoxStudioIV chapter „[The RFID Technology](#)“

The following RFID methods are not supported by the EVO 3.5 Universal:

- Titan, reading the segments
- Q5
- Hitag S
- I-Buton
- ISO 15693

5.9. Fingerscanner optical sensor

In response to many customer requests, we have added a new finger sensor to our product range. This is an optical surface sensor.

RGB LED
 The LED is controlled by the setup of the device.
 See field function
 "Switch the backlight."

Optical area sensor.

Advice:
 The background LED illumination is only on when a finger is placed on the sensor.



With the sensor, a new menu navigation was also introduced for teaching in and deleting the fingers. The menu is called up automatically when the Administration field function is called up in the setup (device configuration).

The menu contains 6 pages: **Check fingers, teach fingers, train fingers; delete individual fingers and delete all fingers. In addition, Finger Writing on Card can be active.**

Input Jumps

A function for field and/or GV execute assignment

Name of the field query:

Text in row 4 of the display:

field name, in accordance:

Field function:

Global variable with PID:

Show / hide pages:ht eingeblendet

- Check fingers
- Teach-in finger
- Training fingers
- Deleting individual fingers
- Delete all fingers of a person
- Writer Finger templates onto card

You can select the individual menu items!

You can also watch the handling of the new finger sensor in our video.

<https://www.datafox.de/video-verwendung-und-einlernen-einer-fingerprntloesung-mit-optischen-flaechensensor.de.html>

5.9.1. Menu Page - Check Finger

This page is used to find out which finger provides the best scan result and how the finger should best be placed on it. To do this, place your finger as straight as possible with light pressure on the sensor. The most important area is the middle of the foremost finger link.

Take your time to select the fingers that provide the best possible image. Please observe the pictures and [instructions](#) below.

If the overall picture is too pale, this could be due to the dryness of the finger. Slight rubbing or breathing on the fingertip improves this considerably, see also the example pictures below.

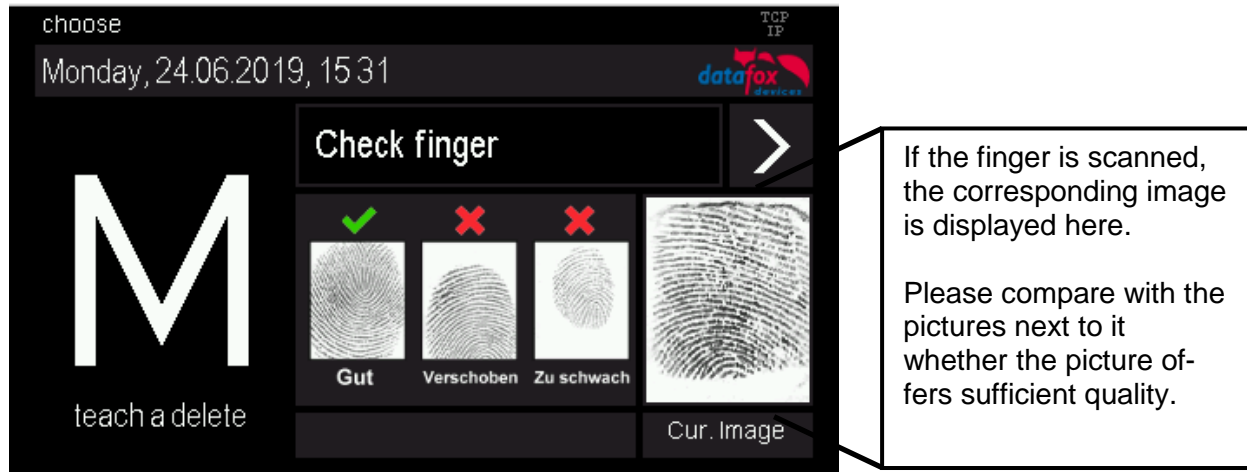

Once you have selected the appropriate fingers, press the arrow  to move to the next page.

5.9.2. Menu page - "Teach in" fingerprints

Select the finger you want to teach in by simply tapping on the corresponding finger shown in the display! The dark grey fields symbolize the two hands, the thumbs are in the middle.

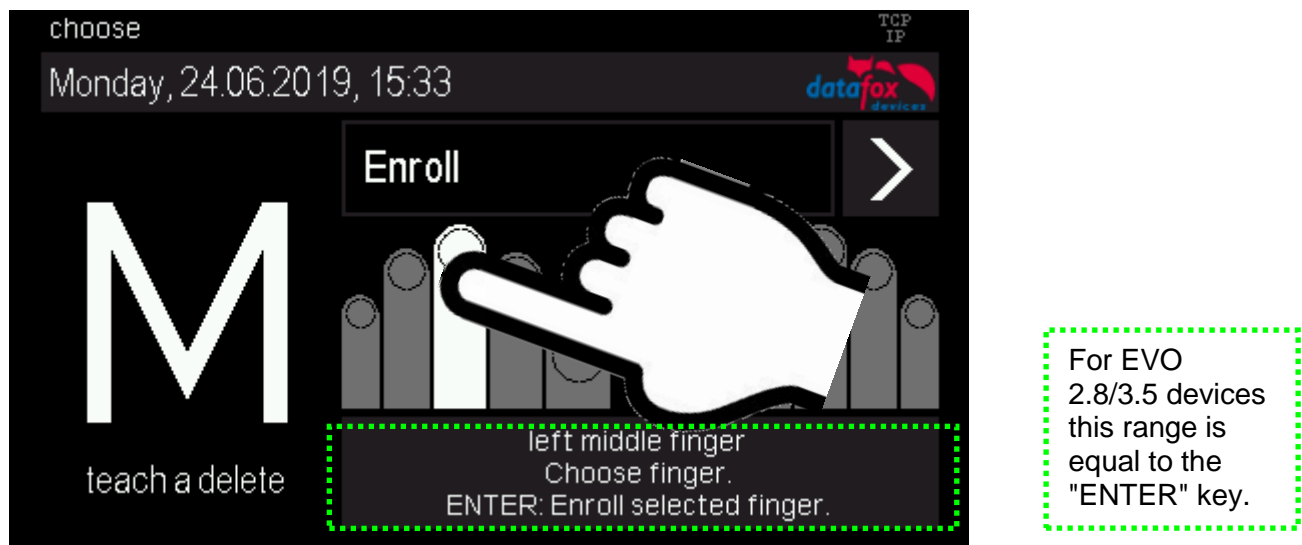

Follow the instructions on the display.

The finger must be scanned 3 times. After each beep, briefly lift your finger off the scanner and replace it.

The successful teach-in is indicated by a green field which also contains a quality value. With a quality value of 85 and more, the teach-in was very successful.

If the values are lower, the teach-in can be repeated directly in order to achieve a better result. Teaching-in should be completed with the highest possible quality value, as this is the basis for later recognition.

Of course, there are fingers that can only reach lower values. In this case, however, other fingers of this person should also be tested.

We recommend to teach in at least two fingers for each user if a finger is not recognizable due to injury.

If you select a different finger symbol, you can then learn additional fingers directly.

5.9.3. "Training" menu page

This step fulfils two tasks, on the one hand a functional check that the taught-in fingers are actually recognized, on the other hand the system can be further optimized, i.e. trained.

To optimize, the fingers should now be deliberately moved or twisted a little.

This way a larger area of the finger will be recognized bit by bit and the saved template will be optimized. An optimization is indicated by the green bar. Good for the system is, if several such optimizations can take place to a finger.

If no more green feedback comes, the training can be stopped.

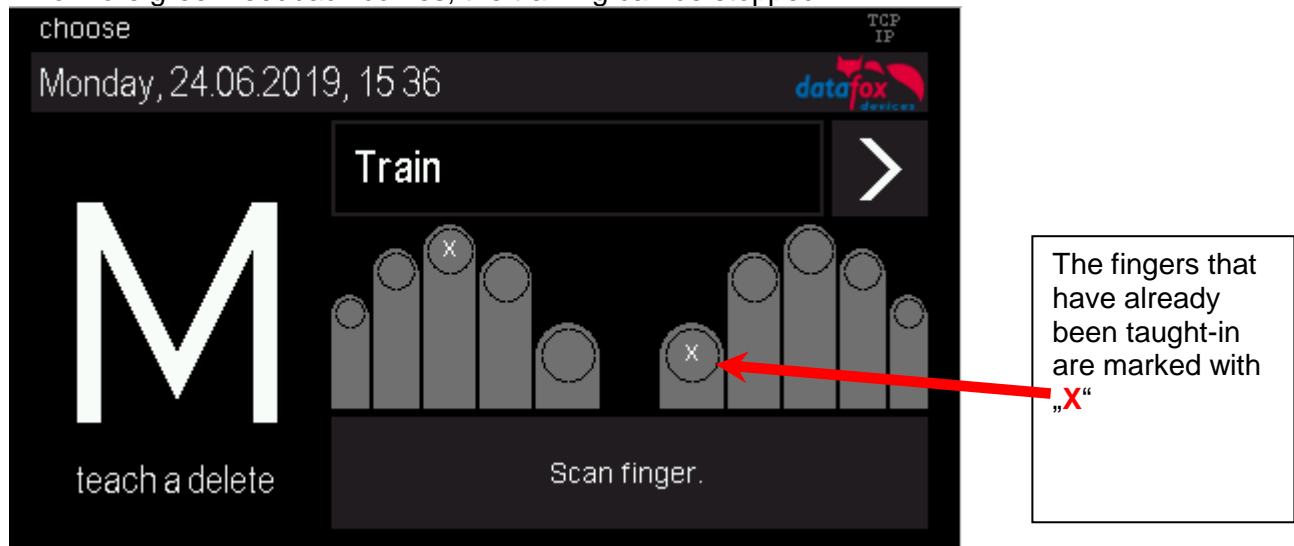

5.9.4. Menu page - Delete

Delete individual fingers:

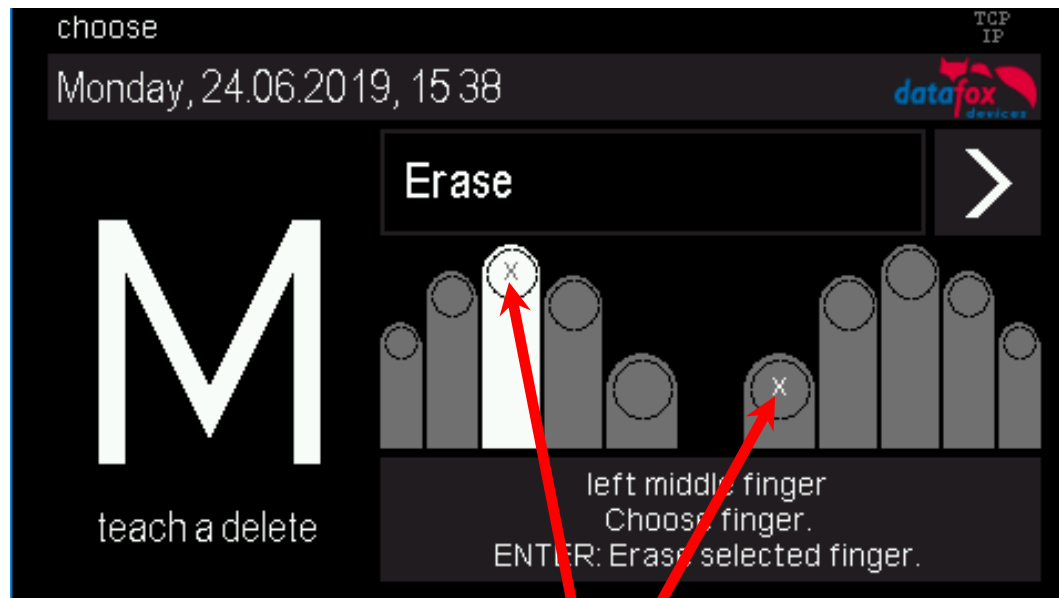

The taught-in fingers are marked with "X".
Tap on the finger you want to **delete** and confirm with "Enter".

Delete all fingers of a person:

On the next menu page "Delete all fingers of a person", all taught-in fingers of the person are highlighted. When you confirm with Enter, all the person's fingers are removed from the fingerprint sensor.

5.9.5. Menu page - "Exit

Menu page - "Exit

For EVO 2.8 and 3.5 there is a separate page for exiting the finger administration menu. Simply click on the center of the screen and exit the menu.

With the EVO 4.3 you can exit the administration menu by pressing the "ESC" key.

Hinweise zur Verwendung des Fingerprint-Flächensensors Hints for using the fingerprint area sensor

Dieser Abschnitt zeigt anhand von Fingerprint Bildern, wie sie auch beim „Finger check“ angezeigt werden, wie ein Bild aussehen sollte und welche Auswirkungen durch schlechte Position, falschen Druck oder ungünstige Finger erkennbar sind.

This chapter shows with images, as they are also shown in the function “Finger check” how a good image should look like and how they could look with respect to bad positions, bad pressure or difficult fingers.

- Der Finger muss mit leichtem Druck auf den Sensor gelegt werden.
The finger must be put onto the sensor with light pressure.
- Der wichtigste Bereich ist die Mitte des vordersten Fingerglieds, da dort die meisten Eigenschaften vorhanden sind.
The most important area is the middle of the front finger link, because there are the most characteristics.
-

Gutes Bild / good image



Schlechte Positionen / Bad positions

Zu weit unten
Too far down



Zu weit oben
Too far up



Zu weit links
Too far left



Zu weit rechts
Too far right



Schlechter Andruck / **Bad pressure on the sensor**

Zu wenig Druck
Too little pressure



Zu viel Druck
Too much pressure



Finger verdreht / **Finger twisted**

Zu steil, nur Finger-
spitze
**Too steep, only finger-
tip**



Nach links verdreht
Twisted to left



Nach rechts verdreht
Twisted to right



Schräg rechts /
Diagonally right



Trockene Finger / **dry fingers**

Finger sehr trocken
Finger very dry



Trockenen Finger kurz
gerieben
**Dry finger shortly
rubbed**



Trockenen Finger an-
gehaucht
Dry finger breathed on



Trockenen Finger ein-
gecremt
Dry finger with cream



Schwierige Finger / Difficult fingers

Falten /
Wrinkels



Unterbrechungen /
Interruptions



Falten, unscharf
Wrinkels, diffuse



Unscharf /
Diffuse



Schwierige Finger / Difficult fingers

Generell Undeutlich /
Generally unclear



Fingerprint Flächensensor Saturn01

Templates	5000 Templates à 640 Byte, ISO19794-4; ANSI-378	In the module 5000 fingers can be managed, a template has 640 Bytes.
Resolution	500 dpi	The sensor-resolution is 500 dpi.
Active area	14 x 18mm	The active area of the sensor is 14 x 18 mm.

6. Technical Data of EVO 3.5 Universal

29.05.2020 EN | TECHNICAL DATA

Housing	Structure	Front panel made of aluminium and glass, capacitive touch, rear housing shell plastic: ABS		
	Dimensions (width x height x depth)	85 mm x 208 mm x 27 mm, ca. 20mm additional in flush mounting (without Option fingerprint)		
	Weight (without power supply)	Basic device 405g plus wall mount plate 170g		
System	Clock	Real-time clock		
Data storage	Flash	4 MB (optional 16 MB), 100.000 write cycles		
Display	LCD	TFT: 320 x 480 Pixel, active area 49,0 x 73,4 mm with LED-Backlight		
Keys	Type and size	Capacitive touch screen, touch area 73,4 x 49,0mm, touch wearless		
Power	Power supply	12 V DC		
	PoE (optional)	PoE module integrated (802.3af), external loads such as access readers up to 300mA		
	Power	Base unit 4 watts, depending on the equipment up to max. 10 W		
	Clock / RAM buffering	Goldcap, securing the time up to one week		
Environment values	Ambient temperature	-20 °C to +50 °C (PoE -20 °C to +40 °C)		
	Protection	Front IP65, Completely IP40 (IP65-Option: Completely IP 65 mounted at the wall)		
Software	Configuration program	Setup program (Datafox-Studio) to configure without programming effort		
	Communication tools	http, DLL or C source code for integration in the application		
Data transmission to PC/Server	USB	Micro-USB integrated		
	TCP/IP	TCP/IP communication with integrated TCP/IP-Stack, 10/100 Mbit		
	RS485	RS485 Bus integrated		
	WLAN (optional)	wireless LAN module integrated, WLAN 802.11 bg und 802.11 n (only 2,4GHz)		
	Mobile Radio (optional)	online via mobile module 2G, 3G or 4G		
Access control functions	RS485 external (ML01-RS485)	Connection of 1 bus with up to 8 external door modules / access readers each		
	Relay	1 Relay change over contact, 30V AC, 30V DC, 2A, max. 60 W		
	Active output	1 active output up to 500mA (12V or GND configurable)		
	Inputs	2 monitored inputs		
	Tamper sensor	Tamper detection with distance control to wall mount plate		
Options	RFID reader integrated	125kHz	Mifare	Legic
		Hitag 1+2+S	Mifare Classic	Legic prime
		Unique EM4102	Mifare Desfire	Legic advant
		Titan EM4450	Mifare Ultralight	
	Fingerprint	Fingerprint module integrated, line sensor or area sensor		

6.1. communication modules

LAN (TCP / IP)	Width 20mm	10 / 100Mbit, IPv4, IPv6
WLAN	Width 20mm	Standard 802.11.b/g, encryption WEP, WPA2 802 / 11i
GPRS	Width 40mm	GPRS class 10, quad band, mini-SIM socket
RS485	Width 20mm	RS485 connections, up to 30 participants

6.2. access modules

RS485	Width 20mm	RS485 connection for the access reader, relay modules, ... power supply from 1 external reader when using Datafox power supplies with 12V
Access Control-IO	Width 20mm	1 relay changeover, 42 V AC, DC 60 V, 2 A, max. 60 W; 1 digital input for monitoring door, ...

6.3. Module digital in and out

Digital inputs	20mm	4 x digital input, functional insulation 230V, depending on the device type, up to 250kHz, Low 0.0 ... 1.0 V; High 3,5 ... 30,0V
Digital outputs relay	20mm	1 x NO contact, 1 x change-over contact, 30 V AC, 30 V DC, 2 A, max. 60 W
Digital outputs Open Coll.	20mm	4 x open collector output, 2A, 30V (in preparation)
Analog inputs voltage	20mm	4 x input, 15-bit resolution, accuracy $\pm 2\%$, range 0-10 V, other ranges and functional insulation 230 V on request

6.4. Modules miscellaneous

RS232-Modul	Width 20mm	RS232 interface, with MiniDIN connector or spring terminal 5V-output max. 0,5A, with USB supply max. 100mA.
GPS	Width 20mm	50 Channels, GPS L1 frequency C/A, GALILEO Open Service L1
Micro-SD Card	Width 20mm	Micro-SD Card max. 2GB, depending on device accessible from outside the device
Mobil-Box-Modul	Width 40mm	Central connector for power supply, (8-30V DC), 1 relay, 2 digital inputs and connection for Mobile-Dockingstation with Timeboy
<i>Acceleration sensor</i>	<i>Width 20mm</i>	<i>3D acceleration sensor in preparation</i>

7. FAQ

An extensive collection of FAQs can be found on our homepage:

<http://www.datafox.de/faq-de.html>

8. Index

B

Bios 20

D

Device 15

DHCP 20

DNS 39

F

FAQ 82

For your Safety 1

H

Holiday Control 41

Holiday control ZK 41

I

Intended Use and Environmental Protection 5
introduction 2

K

Kommunikation 30

Umschalten 30

L

Lautstärke 20

S

System Requirements / Hardware 11

T

TCP/IP 33

Technical Data of EVO 3.5 Universal 81

Touchkalibrierung 20

U

UPS 10

USB 30, 32